

PAPER • OPEN ACCESS

Aspen Plus simulation of optimal biogas production in anaerobic digestion process

To cite this article: R R Ravendran *et al* 2019 *IOP Conf. Ser.: Mater. Sci. Eng.* **702** 012001

View the [article online](#) for updates and enhancements.

Aspen Plus simulation of optimal biogas production in anaerobic digestion process

R R Ravendran, A Abdulrazik* and R Zailan

Faculty of Chemical and Process Engineering Technology, College of Engineering Technology, Universiti Malaysia Pahang, Gambang Campus, Lebuhraya Tun Razak, 26300 Kuantan, Pahang, Malaysia

*E-mail: abdhahim@ump.edu.my

Abstract. The demanding uses of fossil fuels and their associated environmental footprints are driving researches into renewable energy productions from organic resources and waste. Anaerobic digestion (AD) is an environment-friendly and cost-effective method to produce biogas from biomass. This biogas can be used in power generation, heating systems and in a combined heat and power (CHP) system. Nevertheless, biogas produced from AD contains a big fraction of CO₂ and less methane purity. Aspen Plus simulation model was developed for the AD process to produce biogas, highlighting the economical potentials and environmental benefits. Four steps of AD including hydrolysis, acidogenesis, acetogenesis, and methanogenesis with eight reactions were simulated based on the respective stoichiometries. Optimization has involved the search to identify optimum feed flow rate and operating pressure to produce the maximum amount of pure methane. The obtained results showed that optimum feed rate was 0.36 l/day and operating pressure of 3 bar with hydrogen flow of 180 l/day. By using these optimum conditions, maximum amount of methane with high purity was achieved. Otherwise, through biomass natural decomposition, the methane would escape to the atmosphere as one of those significant greenhouse gases.

1. Introduction

Fast population growths and modern livings in general have made energy demands keep increasing. Challenges are to provide the energy in sustainable supply, cheap and not to degrade the environmental qualities. Consolidated efforts to tackle these challenges can be seen through governmental policies, yearly sustainability report by industries, as well as research and developments by universities and research institutions.

The utilization of biomass as an option has pulled interests due to its abundance and ubiquity for almost everywhere. Energy from biomass can be in the form of solid, liquid and gas. Particularly, biogas is the extractable energy from biomass in the gas state, mainly consists of methane and carbon dioxide. These gases are produced from the decomposition of biomass, called as AD, in the absence of oxygen. Once produced and purified, methane can be used for heating, power generation, CHP and vehicle fuels [1-2]. Vehicle fuels require bio-methane with purity above 95% [3]. There are four stages of AD process that include hydrolysis, acidogenesis, acetogenesis, and methanogenesis [4]. Process performance analyses for these four stages of AD are complex due to diverse digestion conditions [5], and this has made almost impossible without an accurate process simulation model. The significance of having



process simulation model in analysis and improvement for biogas production have been highlighted by [6-8].

In terms of substrates used for the AD process, they can be from numerous wet biomass sources such as food and kitchen waste, poultry manure, and primary sludge [9-10]. For the anaerobic digester design, it can be several types such as fixed dome digester [11], horizontal digester [12], flexible balloon digester [13], and so on. As the main motivation was to develop a valid process model, this paper would explain steps in developing Aspen Plus simulation model and optimization for the AD of cow manure to produce biogas. Emphases were given to find optimal flowrates and operating pressure.

2. Simulation Model Development

The process simulation model was constructed primarily based on the hydrolysis, acidogenesis, acetogenesis and methanogenesis stages [4]. These four steps describe on how the complex substrate such as carbohydrates are broken down into simpler substances and lastly to methane and carbon dioxide. The AD process flowsheet was based on the experimental work by [7]. Aspen Plus simulation flowsheet is shown by figure 1. Primarily, all the compounds involved in the flowsheet were obtained, specifically the cow manure that rich in carbohydrates and simulated in the Aspen Plus. In this study, Non-Random Two-Liquid (NRTL) model was selected for the property method since phases involved liquid and gas.

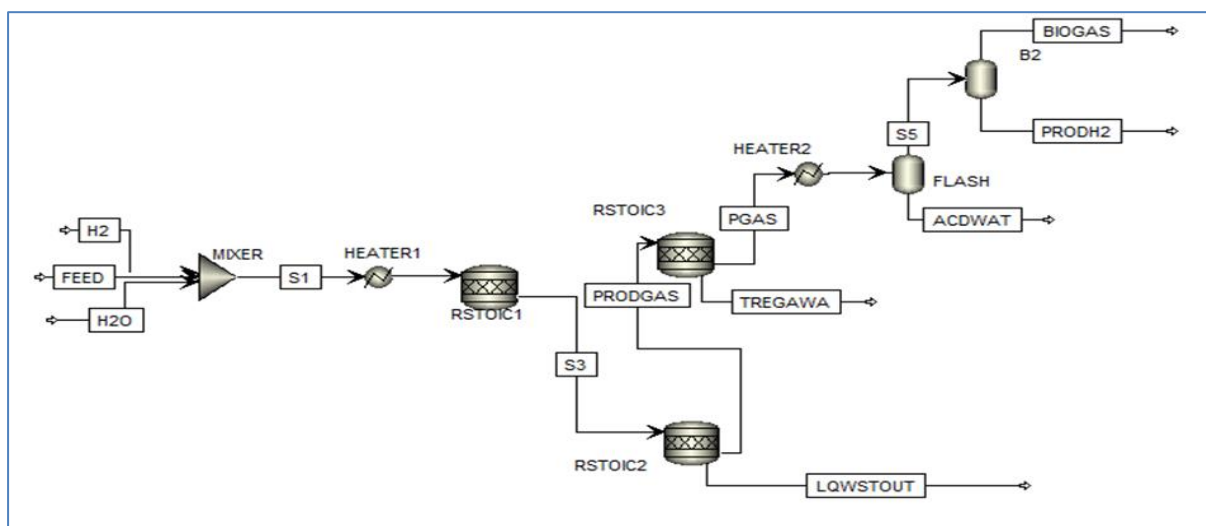

Figure 1. Aspen plus simulation flowsheet of AD process.

All reactor models used stoichiometry reactor (R-Stoic) based on the stoichiometry reactions for the four AD stages. RSTOIC 1 was for hydrolysis, RSTOIC 2 was for both acidogenesis and acetogenesis and RSTOIC 3 was for methanogenesis. The mixer was introduced to mix well the feed with hydrogen and water while the two heaters introduced to increase and maintain temperature of stream in order to achieve efficient conversion in reactors and also for better performance of flash drum. Once after the all reactions complete in three reactors, the product and gases from reactor was flow to flash drum to remove the impurities from biogas. Processing conditions for the units involved in the flowsheet are shown by table 1.

Table 1. Processing conditions in the AD flowsheet.

Model	Conditions		
	Pressure (bar)	Temperature(°C)	Valid phases
Mixer	3	-	Vapor-Liquid
Heater 1	3	37	-
Heater 2	3	53	-
RStoic 1	3	37	Vapor-Liquid
RStoic 2	3	45	Vapor-Liquid
RStoic 3	3	47	Vapor-Liquid
Flash 1	8	53	Vapor-Liquid
Flash 2	10	52	Vapor-Liquid

3. Model Validation

The main criteria for model validations were based on biogas and bio-methane production level from previous works because of the lack of data for the referred flowsheet [7], as well as to have a robust simulation model. Three cases with different substrate and operational data used as to compare and validate. Each case was described as follows:

Case (1): Cow manure has been used as feed which predominantly consists of lignin, cellulose and hemicellulose with input rate of 0.33 l/day with hydraulic retention time of 15 days for hydrolysis reactor or RSTOIC1 of figure 1 [14].

Case (2): Different set up from case 1 with combination of acidogenic and acetogenic in one step. Cow manure was still being used for hydraulic retention time of 25 days [14].

Case (3): Wastewater generated from industrial and agricultural activities was used to feed the reactors with loading rate of 0.30 l/day and hydraulic retention time of 21 days [15].

For validation purpose, equation (1) was used to calculate percentage of methane production from both experiment and simulation results, and plotted. Given A, the amount of methane production (kg/year), and B, total amount of biogas production (kg/year).

$$\text{Percentage of methane production} = \frac{A}{B} \times 100 \quad (1)$$

The acceptable error was calculated using equation (2) and maximum error tolerance was 10% for validation purpose.

$$\text{Error} = [\% \text{ of methane production (simulation)} - \% \text{ methane production (experiment)}] \quad (2)$$

4. Determining Anaerobic Digestion Parameters for Optimality

Determination of optimal parameters value was done by comparing plot of variables against biogas production level with one factor at a time, without any constraint. The aim is to find out the best result for pre-determined ranges. The three important factors were identified that have influenced the bio-methane production. These three factors are: i) substrate feed rate, hydrogen introduction and flowrate, and operating pressure [16]. Therefore, for feed rate factor, simulation analysis was carried out by changing substrate feed flow rate that range between 0.03 l/day to 0.51 l/day. To study influence of hydrogen in AD process, simulations were run with the addition of hydrogen. For effect of pressure, the simulations were performed with six different operating pressures; 0.5 bar, 1.0 bar, 1.5 bar, 2.0 bar, 2.5 bar and 3.0 bar. Based on methane production that was influenced by these factors, the graphs were plotted to suggest optimal factors for the process. Then, the relationship between these factors with economic potentials and environmental benefits were further elaborated.

5. Results and Discussions

Validations of the developed simulation model were done for the three cases as mentioned before for the same process flowsheet. The difference percentage or error values were calculated using both

equation (1) and (2). The differences between the developed models against case 1, case 2 and case 3 for bio-methane production were 3.64%, 3.7% and 5.49 %, respectively. The tolerance was equal or less than 10%. Since all the differences were less than 10%, the model was validated and could be a basis for further improvement.

5.1 Effect of feed rate

Input feed rate and concentration of the substrates played a vital role in the biogas production rate. Figure 2 shows the simulation results of different feed flowrate from 0.03 to 0.51 l/day at 5% concentration of substrates [17]. It shows the maximum production of methane of 41.57 kg/year was achieved when 0.36 l/day of cow manure was a feed. Beyond that flowrate, methane rate began to decline because the excess organics would act as inhibitor at the given condition. Another reason was the amount of unreacted substrate material without reaction to produce methane increased, as studied experimentally by [18]. The optimal feed rate value will be different for other types of biomass feed as each biomass source poses different ultimate and proximate analyses.

Figure 3 shows composition of methane, carbon dioxide and hydrogen in biogas produced for specific feed rates. Amount of methane rate increases with the increase in feed rate which was from 0.03 to 0.36 l/day at a constant substrates concentration. When the feed rate was increased, the product from the reaction that used feed as a reactant also increase. This enabled the methanogens yielded more methane. By using this model with conversion of 90%, more methane gas was trapped with higher composition which was 0.742 (74.2% purity). This proves that the purity of methane increases by using this model in anaerobic digestion process when compared to natural process.

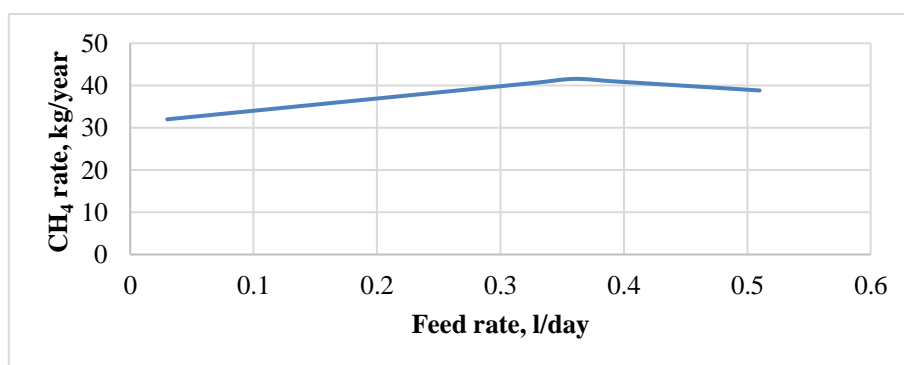

Figure 2. Methane component rate as a function of flow rate for 5% of substrate concentration.

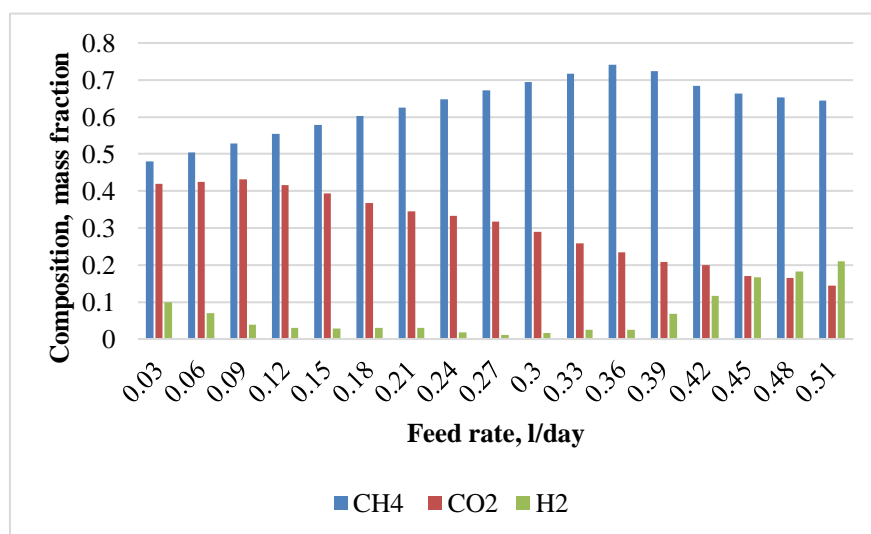

Figure 3. Feed rate against composition of methane, carbon dioxide and hydrogen.

5.2 Effect of hydrogen addition

In studying the effect of hydrogen addition, the previous optimal result i.e. the feed rate at 0.36 l/day was fixed. Addition of a specific amount of hydrogen gas in AD could increase the composition of methane gas in the biogas [16-17]. Introduction of the amount of hydrogen gas however should be equal with amount of hydrogen obtained from the pre-acidification step and also from acidogenic and acetogenic steps. In the developed simulation model, the process run with a supplied hydrogen gas stream and observations were made whether the biogas production and methane gas composition were influenced by hydrogen addition. By theory, the hydrogenotrophic methanogens microorganisms would consume the supplied hydrogen with the carbon dioxide and convert them into pure methane [5].

Once hydrogen gas introduced, the composition of methane in the biogas started to increase until it reached its optimum value as shown by figure 4. After reaching the optimum value, process inhibition occur as the acidity level increases due to greater flow of hydrogen gas into the system. The increasing of acidity level caused decrease in pH value and simultaneously make the hydrogenotrophic methanogens to become inactive. The maximum composition of methane obtained was 0.852 when 180 l/day of hydrogen gas introduced.

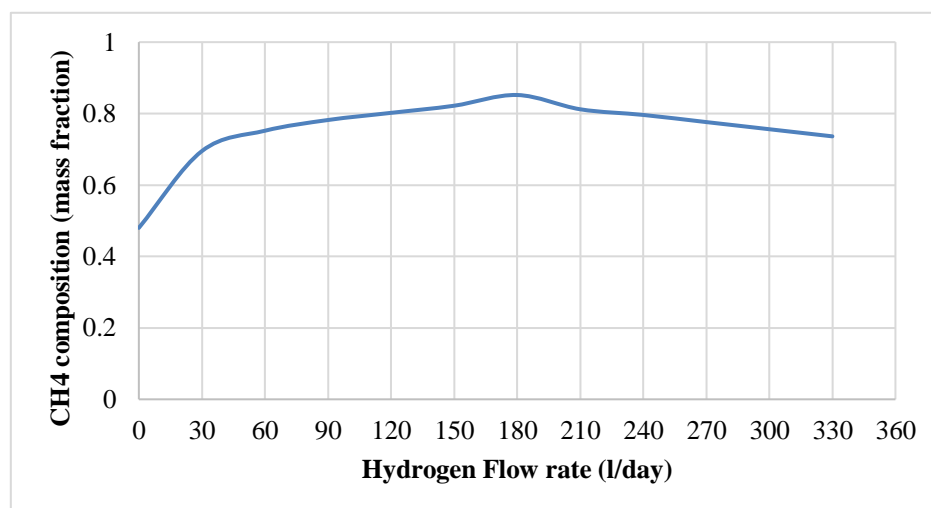

Figure 4. CH₄ composition with H₂ addition.

Figure 5 shows composition of methane, carbon dioxide and hydrogen in biogas produced for specific hydrogen flow rates. It shows more methane was produced and less carbon dioxide released.

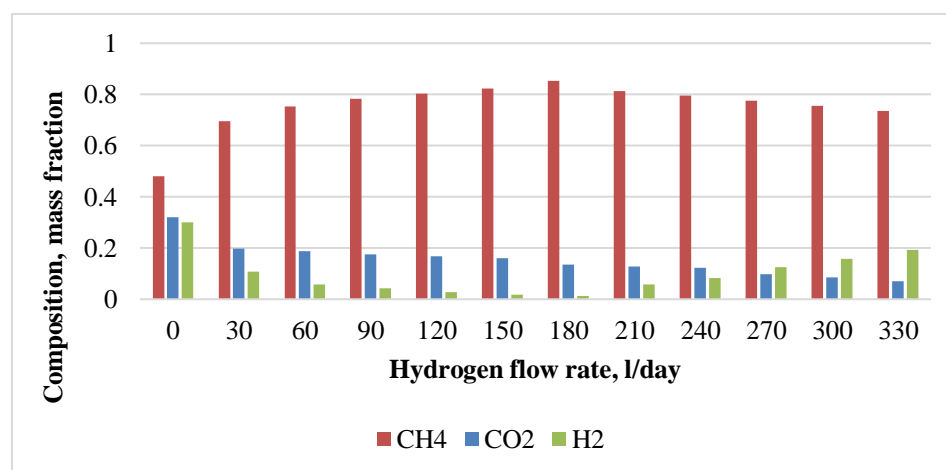

Figure 5. H₂ flowrate against biogas composition.

5.3 Effect of pressure

While the previous results (optimal feed and hydrogen flowrates) were fixed, variations have been made for pressure from 0.5 to 5 bar in the Aspen Plus model. Figure 6 and 7 show the results of varying operating pressures that have affected bio-methane production level and its composition in the biogas, respectively.

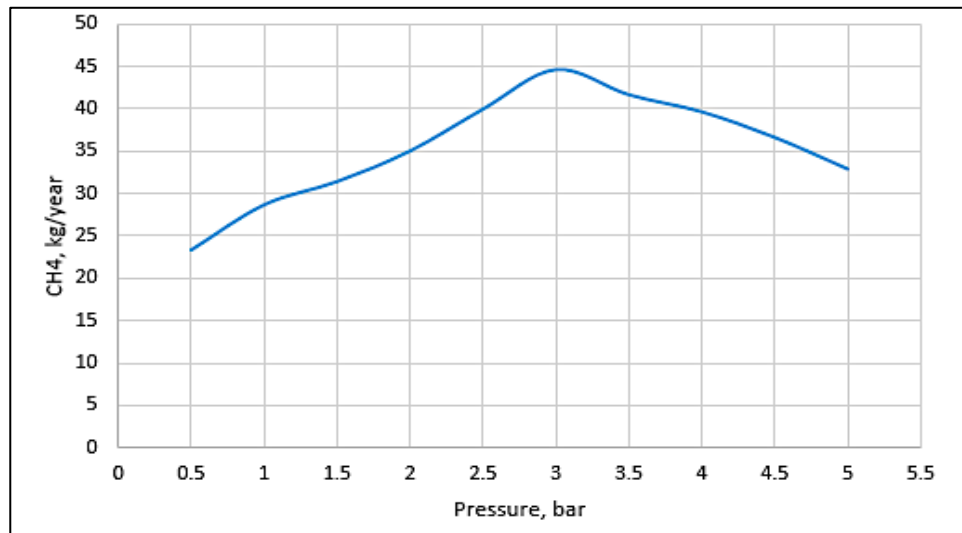

Figure 6. Methane production rate with pressure.

When the operating pressure increased from 0.5 bar to 3 bar, the composition of methane increased from 0.346 to 0.742 and the methane flowrate did from 23.45 kg/year to 44.67 kg/year respectively. From the figure 6, it is observed the optimum pressure is 3 bar with 44.67 kg/hr. Beyond 3 bar of operating pressure, the methane composition and its production rate began to decrease because methanogen could not effectively produce methane and become unstable at high pressure [19]. The effect also can be seen from biogas composition in figure 7.

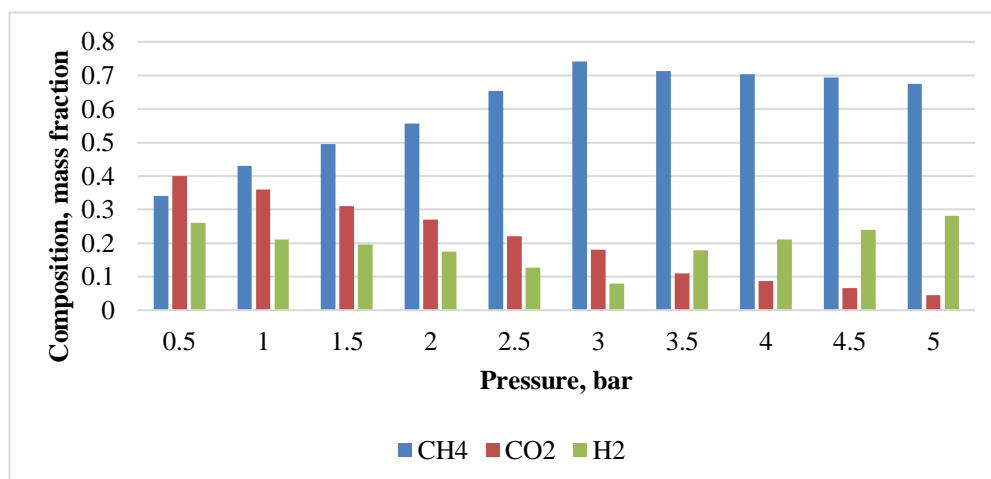

Figure 7. Composition of biogas with pressure variations.

6. Conclusion

An Aspen Plus simulation model has been developed to represent the two-stage AD process that represent the four key steps that convert biomass into biogas. After validation, the model was further simulated to investigate influencing factors to the bio-methane yield. Three factors have identified as suggested and they were feed and hydrogen flowrates, and operating pressure. Simulation results showed that methane composition in the biogas at first increased until reach optimum feed rate and then decreased although the feed rate increases due to the decrease in residence time that the biomass needs to convert to methane. Besides, the simulation results also show that the production of bio-methane was affected by the hydrogen flowrate and operating pressure. The optimal production level of bio-methane (fraction of the biogas) was 0.122 kg/day with 74.2 % purity at the feed flowrate of 0.36l/day, at hydrogen flowrate of 180 l/day, and at pressure of 3 bar. In a nut shell, the produced bio-methane has potentials to substitute natural gas for various applications including heating, power generation and vehicle fuels.

Acknowledgement

This work was funded under the **RDU1703170** research grant and the authors would like to acknowledge Universiti Malaysia Pahang (UMP) for the technical assistances and supports.

References

- [1] Rajendran K, Kankanala H R and Lundin M 2014 A novel process simulation model (PSM) for anaerobic digestion using Aspen Plus *Bio-res. Technol.* **168** 7–13
- [2] Deublein D and Steinhauser A 2011 *Biogas from Waste and Renewable Resources; An Introduction* (US: John Wiley and Sons)
- [3] Papacz W 2011 Biogas as Vehicle Fuel *J. KONES Powertrain and Transport* **18** 403-10
- [4] Chen L and Neibling H 2014 *Anaerobic Digestion Basics* (Moscow: University of Idaho Extension) pp 1-6
- [5] Meegoda J N, Li B, Patel K and Wang L B 2018 A review of the processes, parameters, and optimization of anaerobic digestion *Int. Environ. Res. Public Health* **15** 2224
- [6] Adak A., Mazumder D., and Bandyopadhyay P., 2011 Simulation of a Process design model for anaerobic digestion of municipal solid wastes *Int. J. Environ. and Ecological Eng.* **5** 177-81
- [7] Al-Rubaye H, Karambelkar S, Shivashankaraiah M M and Smith J D 2017 Process simulation of two-stage anaerobic digestion for methane production *Biofuels* 1-11
- [8] Karambelkar S S 2018 *Effect of Variation of Parameters on Biogas Production using Aspen Plus & Dynamic Simulation using Mimic* Master Thesis (Missouri: Missouri University of Science and Technology)
- [9] Iqbal S A, Rahaman S, Rahman M and Yousuf A 2014 Anaerobic digestion of kitchen waste to produce biogas *Proc. Eng.* **90** 657-62
- [10] Aguilar M C and Lamidi R O 2017 Biogas from anaerobic co-digestion of food waste and primary sludge for cogeneration of power and heat, *Ener. Proc.* **142** 70-76
- [11] Saleh A 2012 *Biogas Potential in Pakistan Biomass Conversion Research Centre* COMSATS Institute of Information Technology
- [12] Naik P R 2016 Design, fabrication & performance study of horizontal biogas plant *Int. J. Innovative Res. in Technol.* **3** 311-14
- [13] Tumwesige V 2013 *The Potential of Flexible Balloon Digester to Improve Livelihoods in Uganda - A Case Study of Tiribogo* Master Thesis (Scotland: University of Aberdeen)
- [14] Kaparaju P, Ellegaard L and Angelidaki I 2009 Optimisation of biogas production from manure through serial digestion: lab-scale and pilot-scale studies *Bio-res. Technol.* **100** 701-09
- [15] Forgacs G. 2012 *Biogas Production from Citrus Wastes and Chicken Feather: Pretreatment and Co-digestion.* PhD Thesis (Sweden: Chalmers University of Technology)
- [16] Luo G and Angelidaki I 2012 Integrated biogas upgrading and hydrogen utilization in an anaerobic reactor containing enriched hydrogenotrophic methanogenic culture *Biotechnol. Bioeng.* **109** 2729-736

- [17] Ghorbanian R M, Lupitskyy J V, Satyavolu and Berson R E 2014 Impact of supplemental hydrogen on biogas enhancement and substrate removal efficiency in a two-stage expanded granular sludge bed reactor *Environ. Eng. Science* **31** 253–60
- [18] Giuliano A, Bolzonella D, Pavan P, Cavinato C. and Cecchi F 2013 Co-digestion of livestock effluents, energy crops and agro-waste: feeding and process optimization in mesophilic and thermophilic conditions,” *Bio-res. Technol.* **128** 612–618
- [19] Luo G, Johansson S, Boe K, Xie L, Zhou Q and Angelidaki I 2012 Simultaneous hydrogen utilization and in situ biogas upgrading in an anaerobic reactor *Biotechnology and bioengineering*, **109** 1088-94