



ELSEVIER

Contents lists available at ScienceDirect

Case Studies in Thermal Engineering

journal homepage: www.elsevier.com/locate/csite

Thermal model of a photovoltaic module with heat-protective film

I.M. Kirpichnikova^a, K. Sudhakar^{b,c,d,*}, I.B. Makhsumov^a, A.S. Martyanov^a,
S. Shanmuga Priya^e^a Institute of Engineering and Technology, South Ural State University (National Research University), 76 Prospekt Lenina, 454080, Chelyabinsk, Russian Federation^b Faculty of Mechanical and Automotive Engineering Technology, Universiti Malaysia Pahang (UMP), Pekan, 26600, Pahang, Malaysia^c Energy Centre, Maulana Azad National Institute of Technology, Bhopal, 462003, India^d Department of Electric Stations, Grids, and Power Supply Systems, South Ural State University, Chelyabinsk, Russian Federation^e Manipal Institute of Technology, Manipal Academy of Higher Education, Manipal, 576104, Karnataka, India

ARTICLE INFO

Keywords:

Solar PV
Photovoltaic converter
Thermal protection
Regression analysis
Math model

ABSTRACT

Research on reducing the working temperature of PV modules is gaining attention to improve their electrical performance, efficiency, and life especially in warm climatic conditions. This study describes the use of novel heat-protective film based on holographic coating with a total internal reflection prism layer applied to maintain the operating temperature of the photovoltaic module. A mathematical model of thermal protection based on the holographic film is described. MATLAB/Simulink simulation was used to estimate the current-voltage and output power–solar irradiance characteristics of a photovoltaic module with and without holographic film. Regression models were developed based on field testing to determine a relationship between the temperature of heat-protected/unprotected PV panels and ambient temperature. The results showed that a temperature reduction of 3.54 °C is obtained for solar modules with thermal protection film compared to the one without holographic film. The modeling and field performance results confirm the effectiveness of the thermal protective film in reducing the temperature and improving the photovoltaic panel performance in hot climates.

1. Introduction

In recent years, the use of photovoltaic systems to generate electricity has increased around the world. This in fact can be explained by rapid growth in silicon semiconductor technology together with the support of steady market growth and continuous demand for low-cost electric energy. Besides, photovoltaic energy is green energy, meaning that the solar power plants generate no pollution during energy extraction and save conventional fuel [1]. Solar panels are usually made up of photovoltaic cell materials manufactured using semiconductor technology. The progress in photovoltaic technologies includes a wide range of accomplishments starting from monocrystal silicon to organic nano-sensitized solar cells [2]. New perovskite photovoltaic cells have efficiency up to 25%, but they are unstable with changes in temperature and humidity [3]. Further, at high operating temperatures the perovskite solar cell characteristics deteriorate, which prevents it from being widely used.

The efficiency of commercial photovoltaic devices usually depends on several factors, including solar irradiance, operating temperature, and wind speed [4]. The heating up of the solar panel during the photovoltaic conversion of solar irradiance into electricity

* Corresponding author. Faculty of Mechanical and Automotive Engineering Technology, Universiti Malaysia Pahang (UMP), Pekan, 26600, Pahang, Malaysia.
E-mail address: sudhakar@ump.edu.my (K. Sudhakar).

<https://doi.org/10.1016/j.csite.2021.101744>

Received 25 April 2021; Received in revised form 27 July 2021; Accepted 27 December 2021

Available online 28 December 2021

2214-157X/© 2021 Published by Elsevier Ltd. This is an open access article under the CC BY-NC-ND license

(<http://creativecommons.org/licenses/by-nc-nd/4.0/>).

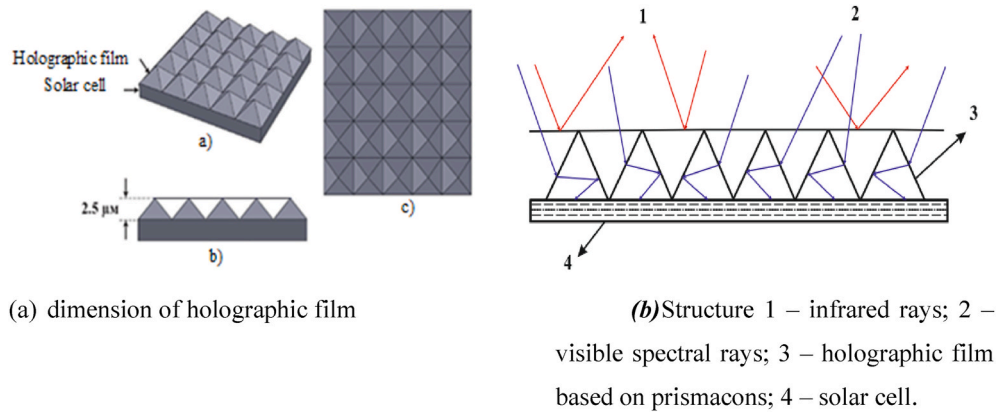

Fig. 1. General view of holographic film.

leads to a faster rate of degradation and a decline in energy efficiency. According to the product specifications, most of the photovoltaic modules degrades up to 80% from the initial state after 25 years of operation [5]. Nevertheless, the time-dependent degradation reported by multiple sources provides different results, indicating the importance of investigating solar panel reliability under various operational conditions for economic reasons.

According to previous research [5], the analysis of PV panel efficiency and durability is critical for proper financial planning, efficient electricity production, and solar energy plant penetration. Maintaining the operating temperature of the PV cell will increase energy generation efficiency and durability, according to experimental data published in Refs. [6,7]. Therefore, it is important to investigate the factors influencing the generation of photovoltaic energy in various climatic conditions.

The paper presents a novel method to reduce the thermal degradation of photovoltaic modules with the use of holographic film. The study aims to develop a temperature-based thermal model of photovoltaic modules with and without thermal protective film in warm climatic conditions. The objective of the simulation is to explore the influence of thermal protective film usage on the effectiveness of electric power generation.

2. Influence of ambient temperature on photovoltaic cell efficiency

Solar photovoltaic energy production is directly proportional to the amount of solar irradiance falling on the panel surface. Some portion of this irradiance is converted into electric energy and the rest of the solar energy heats up the solar panel. This energy has to be removed from the solar panel which can be used for water heating or other useful purposes. The solar irradiance varies with time due to the change in sun movement and cloud cover [8]. High solar irradiance causes overheating of the photovoltaic cells which in turn reduces the conversion efficiency and can lead to the thermal stress of solar panels. As a result, solar irradiance has a highly significant effect on long-term electricity generation.

Meanwhile, optimal solar panel orientation is required for effective solar energy conversion because the energy output is highest when the photovoltaic cell surface is perpendicular to the incoming solar rays [9].

During the photovoltaic conversion process, the majority of incoming solar energy is converted to heat, with only a small portion is converted into electricity. It is well-known that high temperature negatively acts on the energy conversion efficiency of fixed ground-mounted solar panels [10].

Consequently, at higher solar irradiance and with high ambient temperature, the photovoltaic cells get overheated. It is very significant in warm and hot climate conditions, where the temperature of silicon cell temperature can reach up to 80 °C [11]. In this case, the probability of failure of solar cell increases additionally reducing the output power and decline in the lifetime of the solar panel. So, the temperature of the photovoltaic module (T_m) is one of the most important factors which influence the effectiveness of electric power generation.

Photovoltaic module temperature can be found according to (1) [12]:

$$T_m = T_a + \frac{NOCT - 20}{800} \cdot G \quad (1)$$

where NOCT – Nominal Operating Cell Temperature according to cell material, °C; T_a – ambient temperature, °C; G – solar irradiance W/m^2 .

The performance of a photovoltaic cell varies with temperature due to changes in the diode's voltage and current [13]. The voltage and output power of solar cells decrease as the temperature increases for constant solar irradiance.

3. Description of the thermal protection (Holographic) film for solar panels

Many of the heat removal techniques from the solar module are complex in design. A holographic film based on prismatic concentrators known as “prismacons” made of a translucent material containing holographic lenses of infinitely small dimensions is being

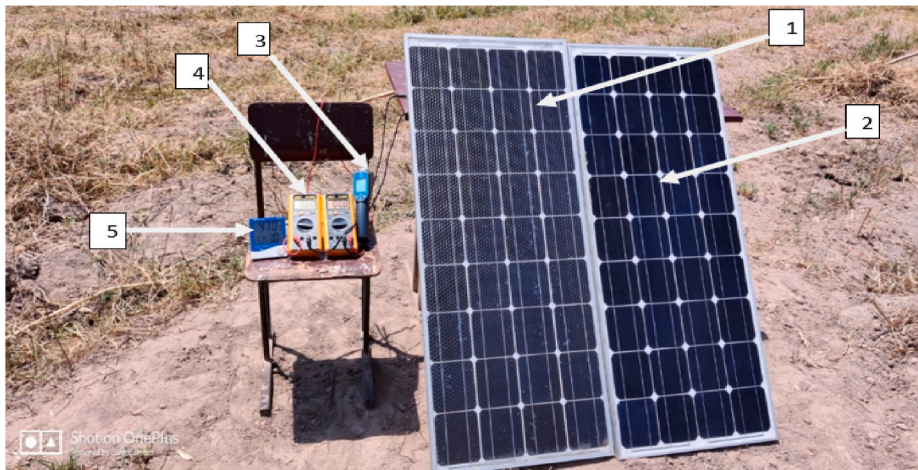

Fig. 2. Field test setup: 1- Module with protective film, 2- Module without protective film; 3 - Infrared thermometer; 4 – Digital multimeter; 5 - Thermometer.

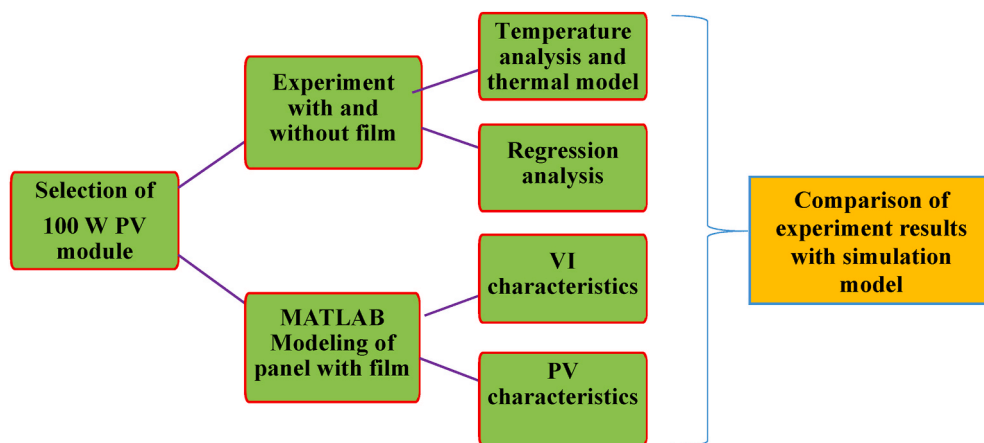

Fig. 3. Flow chart of the experimental study.

researched. To reduce module temperature and avoid overheating of photovoltaic modules, a special holographic film is proposed in this work as an alternative technique for protecting solar modules from high temperatures. The basic theory of a holographic film is that the sun's rays strike the module's surface, while part of the spectrum – infrared rays – is reflected from the film's metalized top layer, preventing the module from overheating. These prisms have equal edges connected to each other according to Fig. 1. The key internal structure of the holographic film is a layer of tiny mini pyramids/spectral concentrators that absorb light rays and refract them multiple stages before directing them on the solar cell due to internal reflection, regardless of the angle of incidence [14]. The prism dimensions are chosen according to Ref. [15] to provide the maximum power output and energy generation efficiency. This structure of holographic film used in the research is at both the experimental stage and mathematical modeling. Several types of holographic foils and patterns have been tested in various applications.

4. Materials and methods

The experimental and simulation studies of PV module with and without the filter is described in the following section.

4.1. Experimental setup of PV module used in the research

The experimental work is aimed to study the influence of thermal protection film on PV panel operating temperature in real conditions.

Experimental research was carried out in July 2019 in the Tajikistan Republic. The experimental site is located near Qurghontepa (officially known as Bokhtar) with coordinates 37°50'N 68°46'E. The setup consists of two identical monocrystalline modules manufactured by DELTA (20–100 MONO) with a rated power of 100 W. Both the PV modules were mounted to a fixed stand at an inclination angle of 45° to experience similar operating conditions. The general view of the experimental setup and the measuring instruments used for the research is shown in Fig. 2. One of the modules was equipped with holographic film, while the other one was

Table 1
Percentage of Uncertainties.

Instruments	Range	Accuracy	Make/Model	Percentage uncertainties
Digital multimeter	20A 200V	$\pm 0.2\% + 5$ $\pm 0.5\% + 3$	CHY Victor VC890D	± 0.03
2-point infrared thermometer	-60 °C-1000 °C	$\pm 1\%$ or 1 °C	Dostmann 5020-0490 ScanTemp 490	± 0.09
Thermometer with air humidity measurement function	-50 -70 °C 10–99% RH	$\pm 1\text{ °C}$ $\pm 5\%$	TH-90	± 0.8 ± 0.9

without the film. The ambient temperature was measured using a thermometer with the function of measuring air humidity TN-90 ($\pm 1\text{ °C}$) and data from a smartphone in real-time. The surface temperature of the modules was measured using a two-point infrared thermometer Dostmann, ScanTemp 490 ($\pm 1\text{ °C}$). The load current and voltage are measured using digital multimeters CHY Victor VC890D ($\pm 0.2\%$ and $\pm 0.5\%$). Two 12 V/45/40 W incandescent lamps were connected directly to the modules as load. The readings were recorded for the entire duration of sunshine hours from 7 a.m. to 6 p.m. The experiment was repeated on consecutive days with very little variation in the climatic conditions. The collected data were averaged and processed in Excel. Following the data collection and processing of the measured data, a regression model has been developed to determine the relationship between the panel and the ambient temperature.

The methodology of the research work is presented in a simple flowchart as shown in Fig. 3. The study includes the simulation modeling of the PV panel with and without the filter. A comparative analysis of the PV panel temperature with and without thermal protective film is carried out along with the simulation model.

4.2. Experimental uncertainty

Usually, uncertainty arises based on various conditions like the selection of instrument, its calibration, working environment, accuracy, and observation of an experiment. Generally, the reliability of an experiment is supported with the help of uncertainty analysis. So, in this study, a detailed uncertainty analysis has been carried out to fix the uncertainty of the experimental results. The same is displayed in Table 1.

The uncertainty of a sum is the square root of the sum of the squares of the un-certainties of the summed quantities

$$\begin{aligned} &= \sqrt{\{(Tm)^2 + (Vm)^2 + (Im)^2\}} \\ &= \sqrt{\{(1)^2 + (0.2)^2 + (0.5)^2\}} \\ &= \pm 1.1\% \end{aligned}$$

Based on the accuracy and precision of the instrument used, the overall uncertainty in the analysis is around $\pm 1\%$. The above indicates that reduced uncertainty has been obtained in the observations.

4.3. Simulation model of PV cell used in the research

The simulation model was developed based on the equations presented in the [19].

The output current of PV cell is:

$$I = I_{pv} - I_d - I_{sh}, \quad (2)$$

where I_{pv} – photo-current, I_d – diode current, I_{sh} – shunt current.

Photo-current mostly depends on irradiance and temperature and can be determined according to the following equation:

$$I_{pv} = (I_{pv,n} + K_I \Delta_T) \frac{G}{G_n}, \quad (3)$$

where $I_{pv,n}$ – photo-current at standard conditions (25 °C , 1000 W/m^2), K_I – current-temperature coefficient, Δ_T – difference between standard and actual temperature), G – irradiance, G_n – standard irradiance, 1000 W/m^2 .

Diode current defines by the next equation:

$$I_d = I_0 \left[\exp\left(\frac{V + R_s I}{n V_t}\right) \right], \quad (4)$$

where I_0 – diode saturation current, V – load voltage, $R_s I$ – drop voltage on serial resistance, n – coefficient of idealization, describing the difference between real and ideal volt-current curve, V_t – thermal voltage.

Saturation current can be determined from the equation described in the [19]:

$$I_0 = \frac{I_{sc,n} + K_I \Delta_T}{\exp\left(\frac{V_{oc,n} + K_V \Delta_T}{n V_t}\right)}, \quad (5)$$

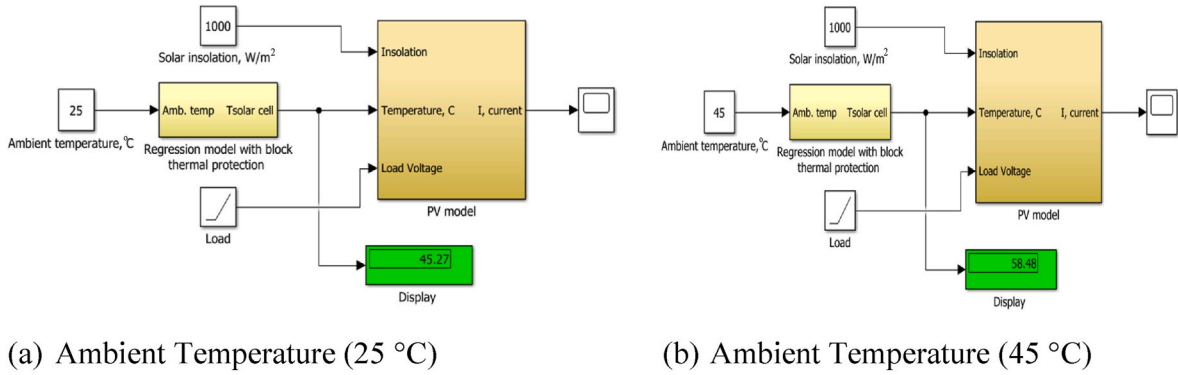

Fig. 4. Model of PV cell with thermal protective film.

Thermal voltage is

$$V_t = KT/q, \quad (6)$$

where K – Boltzmann constant, T – temperature, q – electron charge.

And the last equation is the current through the shunt that is

$$I_{sh} = \frac{V + R_s I}{R_{sh}}, \quad (7)$$

This model was used as the base for comparative analysis of two models explored, with and without thermal protective film. Both the model was tested in similar conditions, with equal applied load.

4.4. Simulation modeling of a photovoltaic module with and without thermal protection film

In order to demonstrate the effectiveness of thermal protection film usage, the simulation model of the solar panel was developed in MATLAB/Simulink. The characteristics of modeling conditions are as follows:

- irradiance is equal to the standard condition of 1000 W/m²;
- PV cell is loaded by the resistance that is variable during simulation;
- internal resistance is 0.5 OhM;
- standard temperature condition (STC) is +25 °C;
- ambient air temperature is +45 °C.

Fig. 4, presents the complete structure of the Simulink model of PV cell with a protective film to estimate the PV cell temperature depending on ambient temperature, and solar insolation. A similar model was constructed in MATLAB for the simulation of solar cells without thermal protective film.

The model is built according to the following assumptions: irradiance concentration in total reflection prisms is 3.3 according to Refs. [18,22]; ambient temperature is 25 °C and 45 °C

5. Results and discussion

5.1. Thermal model of PV module with and without thermal protective film

Experimental results indicated that the holographic film with a total reflection prism layer helps to reduce the temperature of photovoltaic cells and increase the energy output [16]. The data obtained during experimental research with the holographic film were used to derive relationships between photovoltaic temperature (as dependent variables) and ambient temperature (as the independent variable) [17]. The module operating temperature was found to vary between 35 °C to 75 °C without holographic film. All the results were processed in Microsoft Excel [18].

Fig. 5 (a) and (b) shows the temperature of a photovoltaic module with and without holographic film at various ambient temperature. This result allowed us to estimate the relation between PV temperature and ambient temperature at different operating conditions. The module operating temperature was found to vary between 32 °C to 65 °C with holographic film. Based on the data distribution presented in Fig. 5 (a) and (b), the regression model of the thermal protective film was developed to determine the temperature difference of the solar module with a thermal protective film which is presented in Fig. 5 (c).

The performance of photovoltaic modules at different ambient temperatures with and without a thermal protective film is presented in Table 2.

In this work, important correlations with holographic thermal insulation film were obtained based on experiments without major assumptions or simplifications. The thermal model used in predicting the temperature of the PV module is important as the module temperature affects its power output. The relations obtained are useful to determine the module temperature in arid continental

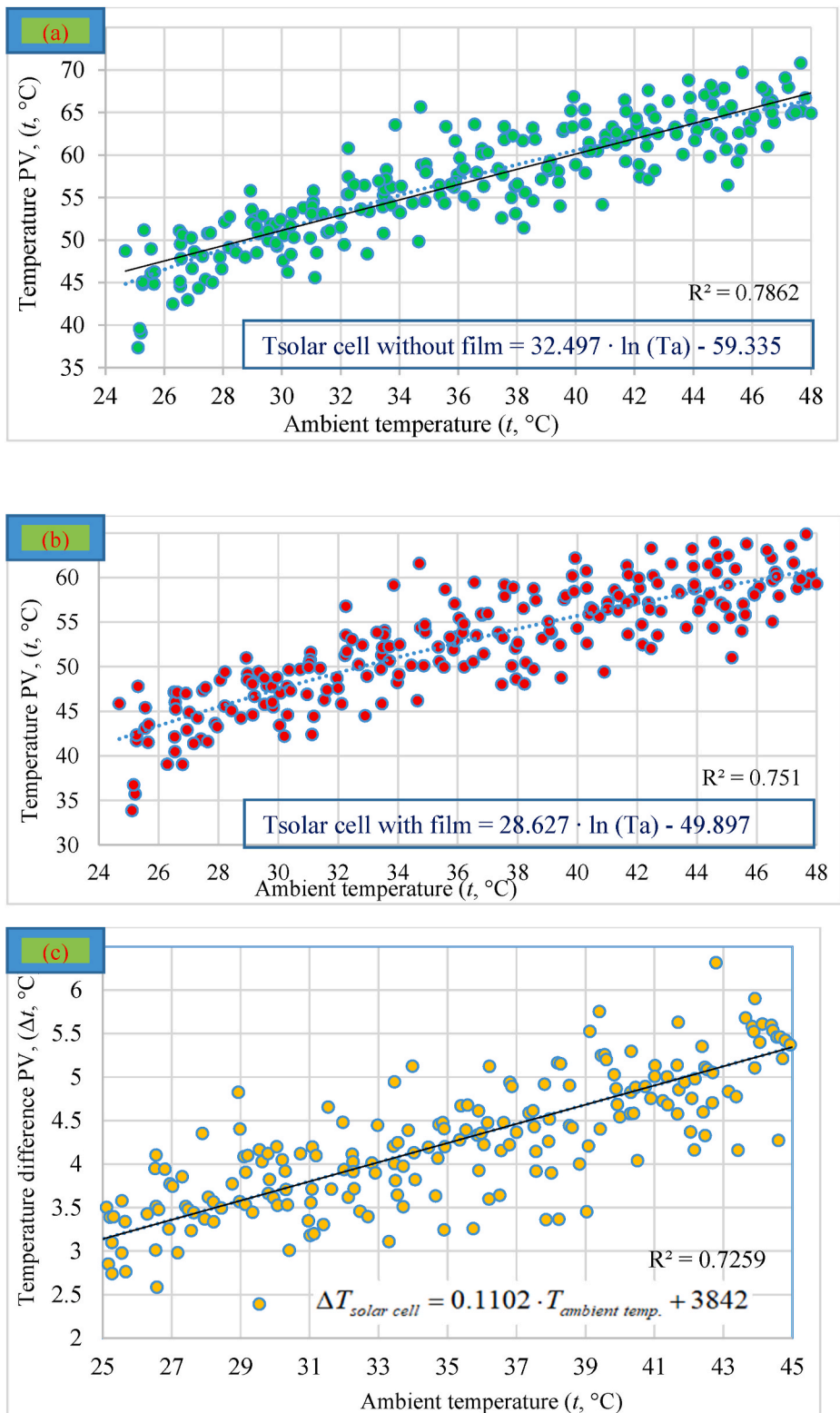

Fig. 5. (a), (b), (c) Relationship of the surface temperature of modules to the ambient temperature with and without film.

Table 2
Effect of a thermal protective film on power and temperature of photovoltaic modules.

Ambient temperature, $T_{amb.temp.}$ (°C)	Photovoltaic module temperature without film, T_{PV} (°C)	Photovoltaic module temperature with film, T_{PV} (°C)	Maximum power of PV module without film, P_{max} (W)	Maximum power of PV module with film, P_{max} (W)	PV power difference, (%)
15	28.67	27.63	101.3	101.4	0.098
20	38.02	35.86	100.10	100.4	0.298
25	45.27	42.25	99.16	99.58	0.423
30	51.19	47.47	98.53	98.93	0.405
35	56.20	51.88	97.96	98.45	0.50
40	60.54	55.70	97.44	98.02	0.595
45	64.37	59.08	96.96	97.62	0.68
50	67.79	62.09	96.51	97.24	0.756
55	70.89	64.82	96.10	96.90	0.832

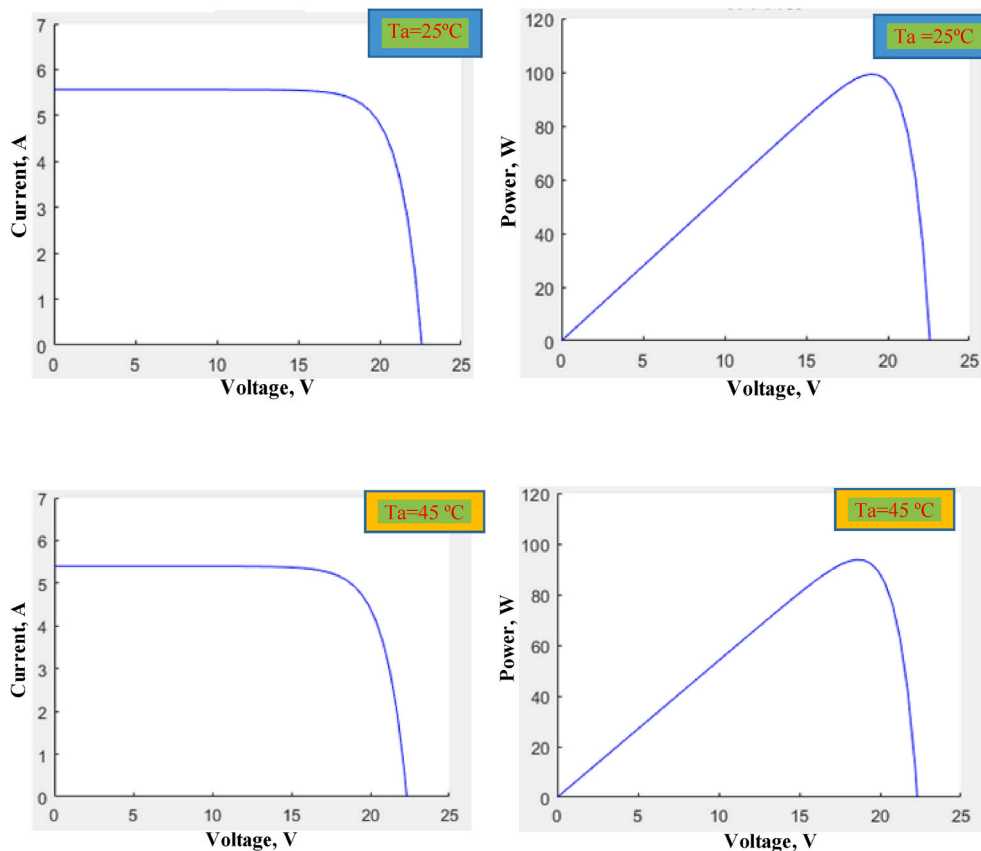

Fig. 6. Volt-current and output power without thermal protective film at STC 25 °C and 45 °C

climates for the mono-crystalline module. The thermal model equation obtained in this study can be used in simulation modeling of a solar energy power plant based on photovoltaic panels temperature. The model accuracy is verified with the closeness of the fit and MATLAB simulation values. R-square measures the strength of the relationship between the model and the dependent parameter. R^2 value of 0.75 shows the strong positive linear relationship between ambient and module temperature. The model strength can be further enhanced by considering solar radiation and wind speed data. Further, it can be used to evaluate the power output and performance of the solar module with long-term experimental data. It is recommended that the proposed simple thermal models need to be improved to predict more accurately the temperature and power output of PV modules with and without thermal protective film.

5.2. Simulation results

The temperature of the solar panel increases with ambient air temperature, in some cases on a hot sunny day the surface of the solar cell can reach 45 °C and more. As a rule of thumb, as the module operating temperature rises by 1 °C, the output power of silicon PV cells decreases by 0.4%. It means the photovoltaic module, rated for 200 W output power at 20 °C, produces only 180 W [20,21]. During the simulation modeling, the volt-current and output power curves were obtained (Fig. 6). These characteristics do not take

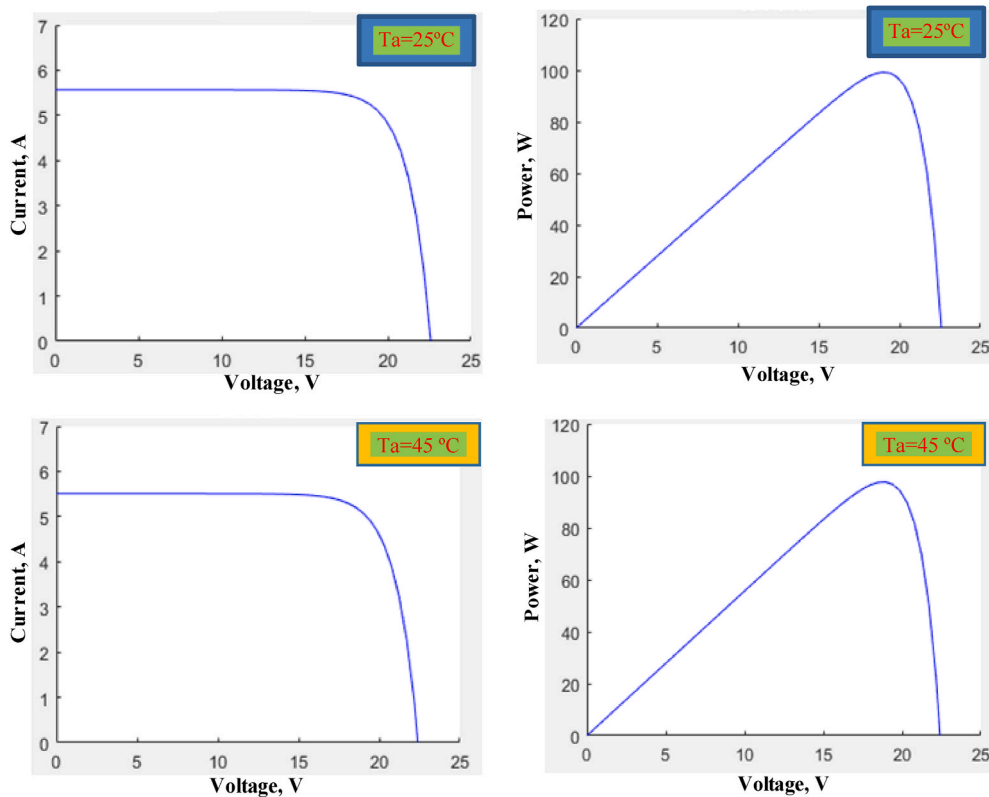

Fig. 7. Volt-current and output power with thermal protective film at STC 25 °C and 45 °C.

into account the thermal protective film and are estimated for the STC conditions of 25 °C and ambient air temperature of 45 °C.

According to the proposed model, the temperature of the PV cell surface reaches 43.73 °C at an ambient air temperature of 25 °C, and 58.47 °C at an ambient air temperature of 45 °C. The volt-current and output power curves at STC and 45 °C with the thermal protective film are presented in Fig. 7. For example, at the ambient air temperature of 25 °C, the PV cell temperature raises up to 45.27 °C. At this condition, the power losses and decline of efficiency of the solar panel are not very high. But if the ambient temperature gets warmer up to 45 °C, the efficiency of the solar module reduces. The silicon surface temperature reduction is 3.54 °C, according to the data analyzed in this work. According to simulation findings, even a small temperature difference of 3.54 °C improves electric power generation performance significantly in larger solar systems under hot and warm climatic conditions. The temperature analysis of this study is in line with other studies which also highlight the importance of filters, cooling, and thermal modeling of the PV modules [23–25].

6. Conclusions

This paper presents a thermal model of a photovoltaic module with heat-protective film for temperature analysis in an arid continental climate. The following are the main conclusions that can be formulated from the research study:

1. According to several published studies in various environmental conditions and the present study, the temperature of the photovoltaic module is greatly influenced by the ambient air temperature. It is the most significant factor affecting the efficiency and power output of PV modules.
2. Simple, very thin, a flexible protective film presented in this study resulted in 3.54 °C temperature reduction compared to solar modules without film. The novel holographic thermal film can be laminated on any type of PV panel including thermal-photovoltaic devices and is expected to act as the thermal filter.
3. The decrease in temperature of photovoltaic modules with film occurs due to the sputtering of rare earth metals located on the upper side of the holographic film which reflects and absorbs infrared radiation from the solar spectrum.
4. Based on the aforementioned research, regression models for modules with and without thermal protective film are obtained, which describe a linear relationship. The thermal protective film's effectiveness in hot and warm climatic conditions was validated using a thermal model created in the MATLAB/Simulink environment, which yielded consistent results.
5. The thermal models need to be improved to be able to predict more accurately the temperature and power output of PV modules with filters in other climates. The effect of sunlight is not considered in the model is a major limitation of the developed model.
6. In the near future, the economics of thermal protection film for large-scale solar PV plant applications should be evaluated.

7. The performance of the holographic films on different types of modules in various other climate conditions can be taken up as future scope of study with research collaborations at the International level.

CRediT authorship contribution statement

I.M. Kirpichnikova: Conceptualization, Resources, Supervision. **K. Sudhakar:** Formulation, Writing – review & editing. **I.B. Makhsumov:** Visualization, Writing – review & editing. **A.S. Martyanov:** Visualization, Writing – review & editing. **S. Shanmuga Priya:** Writing – review & editing, Visualization, Formal analysis.

Declaration of competing interest

The authors declare that they have no known competing financial interests or personal relationships that could influence the work reported in the manuscript. The opinions/views/facts/findings/insights/discussions in the manuscript are solely of the authors and do not necessarily reflect the opinion of any organization involved directly or indirectly. The assumptions and case studies reported within this article are only examples and are based on minimal open-source information. The authors are not responsible for any consequences thereof with the use of information presented in work. All rights reserved to the rightful owner. No copyright infringement intended. The authors declare that they have no known competing financial interests or personal relationships that could have appeared to influence the work reported in this paper.

Acknowledgments

The authors are grateful for the support provided by South Ural State University (SUSU). The collaborative support from Universiti Malaysia Pahang is also greatly acknowledged. The authors acknowledge that the information and materials may contain assumptions, inaccuracies, or errors. So, the authors of this manuscript expressly exclude the liability for any such inaccuracies or errors to the fullest extent permitted by Law. The opinions or facts or insights and discussions in this document are sole of the authors. It does not necessarily reflect the policy and standpoint of any organization directly or indirectly. Hence the authors are not responsible for any consequences thereof with the use of information presented in this work.

References

- [1] A.F. Routhier, C. Honsberg, Using PV and thermal energy storage to decrease carbon dioxide emissions, in: 2018 IEEE 7th World Conference on Photovoltaic Energy Conversion, WCPEC 2018 - A Joint Conference of 45th IEEE PVSC, 28th PVSEC and 34th EU PVSEC, Institute of Electrical and Electronics Engineers Inc, 2018, pp. 1477–1480, 8548133.
- [2] Lujia Xie, Taiyang Zhang, Yixin Zhao, Stabilizing the MAPbI₃ perovskite via the in-situ formed lead sulfide layer for efficient and robust solar cells, *J. Energy Chem.* 47 (August 2020) 62–65.
- [3] B. Philippe, M. Saliba, J.-P. Correa-Baena, U.B. Cappel, S.-H. Turren-Cruz, M. Gratzel, Chemical distribution of multiple cation (Rb⁺, Cs⁺, MA⁺, and FA⁺) perovskite materials by photoelectron spectroscopy, *Chem. Mater.* 29 (2017) 3589–3596.
- [4] S. Singhal Verma, Solar PV performance parameter and recommendation for optimization of performance in large scale grid connected solar PV plant, *J. Energy Power Sourc.* 2 (1) (2015) 40–53.
- [5] D.C. Jordan, S.R. Kurtz, K.T. Vansant, J. Newmiller Compendium of photovoltaic degradation rates, *Prog. Photovoltaics Res. Appl.* 24 (2016) 978–989.
- [6] I.M. Kirpichnikova, Investigation of the surface temperature of solar modules using holographic overheating protection, in: I.M. Kirpichnikova, I.B. Makhsumov (Eds.), *Electr. Data Process. Facilit. Syst.* 15 (4) (2019) 19–29.
- [7] I.M. Kirpichnikova, in: I.M. Kirpichnikova, I.B. Makhsumov (Eds.), *Increasing the Energy Efficiency of Solar Modules by Lowering the Surface Temperature*, vol. 2, Izvestiya Tula State University. Technical science, 2020, pp. 489–499.
- [8] L.J. Piotrowski, M.G. Simoes, F.A. Farret, Feasibility of water-cooled photovoltaic panels under the efficiency and durability aspects, *Sol. Energy* 207 (2020) 103–109.
- [9] M. Mehrtash, Q. Guillermo, D. Yvan, R. Daniel, Performance evaluation of sun-tracking photovoltaic systems in Canada, in: *Proceedings of the 20th Annual International Conference on Mechanical Engineering, ISME, 2012*, pp. 16–18.
- [10] L.J. Piotrowski, E.F. Vaz, F.A. Farret, Optimization of photovoltaic generation by temperature control, in: *Proceedings of the 11th Seminar on Power Electronics and Control, 2018*, pp. 1–6.
- [11] K. Sudhakar, Noopur Jain, Shivani Bagga, in: *Effect of Color Filter on the Performance of Solar Photovoltaic Module Proceedings of the 35th IEEE International Conference on Power, Energy and Control, 2013*, pp. 1027–1031.
- [12] Colmenar-Santos A. Buendia-Esparcia, C. Palacio-Rodríguez, D. Borge-Diez, Water canal use for the implementation and efficiency optimization of photovoltaic facilities: tajo-Segura transfer scenario, *Sol. Energy* 126 (2016) 168–194.
- [13] F.A. Farret, M.G. Simões, *Integration of Renewable Sources of Energy*, second ed., John Wiley and Sons, New York, 2018.
- [14] I.M. Kirpichnikova, I.B. Makhsumov, E.A. Sirotkin (Eds.), Holographic Film Based on Prismacons (Utility Model): Pat. № 201526 Russian Federation: MIIK H01L 31/054 (2014.01), vol. 36, *Bulletin*, 21.12.2020, p. 7. № 2020132145; application. 30.09.2020.
- [15] I.M. Kirpichnikova, Application of solar concentrators for increasing of solar power generation, in: I.M. Kirpichnikova, I.B. Makhsumov (Eds.), *IEEE Russian Workshop on Power Engineering and Automation of Metallurgy Industry: Research & Practice (PEAMI)*, Russian Federation, Magnitogorsk, 2020, pp. 93–97.
- [16] I.M. Kirpichnikova, Investigation of surface temperature of solar modules using holographic overheating protection, in: I.M. Kirpichnikova, I.B. Makhsumov (Eds.), *IEEE Russian Workshop on Power Engineering and Automation of Metallurgy Industry: Research & Practice (PEAMI)*, Russian Federation, Magnitogorsk, 2019, pp. 80–84.
- [17] J. Chantana, A. Kamei, T. Minemoto, Influences of environmental factors on Si-based photovoltaic modules after longtime outdoor exposure by multiple regression analysis, *Renew. Energy* 101 (2017) 10–15.
- [18] I.B. Makhsumov, *PhD Dissertation (Development of an Energy Complex Based on Renewable Energy Sources for Power Supply of Remote Regions of the Republic of Tajikistan Using Thermal Protection of Solar Modules)*, South Ural State University, Chelyabinsk, 2021 (in Russian).
- [19] Zainab Sh Abdulridha, Andrey S. Martyanov, Nikita A. Martyanov, Simulation model of hybrid renewable energy system, in: 2020 International Conference on Industrial Engineering, Applications and Manufacturing (ICIEAM), Sochi, Russia, May 2020, pp. 1–7. Russia 18-22.
- [20] Richard Gaughan, How Does Temperature Affect Solar Panels? [Electronic resource]. – Access mode, 20.06.2020 date of the application, <https://sciencing.com/temperature-affect-solar-panels-20687.html>.
- [21] Kirpichnikova I. Makhsumov, Z. Madiyar, I. Abdulloev, K. Boboev, P. Shohnazarov, in: *Study of the Operation of Solar Modules Using Holographic Thermal Protection//International Scientific Conference on Energy, Environmental and Construction Engineering (EECE-2019)*. E3S Web of Conferences, vol. 140, Russian Federation, St. Petersburg, 2019, pp. 1–5.

- [22] I.M. Kirpichnikova, I.B. Makhsumov, A.S. Martyanov, Z.Sh Abdulridha, Certificate of State Registration of a Computer Program N^o 2021613996, Simulation model of a photoelectric converter, 2021. Application N^o 2021613139. Published on 03, 17.
- [23] K. Sudhakar Pushpendu Dwivedi, E Solomin Archana Soni, I. Kirpichnikova, Advanced cooling techniques of P.V. modules: a state of art, Case Stud. Therm. Eng. 21 (2020), 100674, <https://doi.org/10.1016/j.csite.2020.100674>.
- [24] B. Ramkiran, C.K. Sundarabalan, K. Sudhakar, Performance evaluation of solar PV module with filters in an outdoor environment, Case Stud. Therm. Eng. 21 (2020), <https://doi.org/10.1016/j.csite.2020.100700>, 100700, ISSN 2214-157X.
- [25] B. Tuncel, T. Ozden, R.S. Balog, B.G. Akinoglu, Dynamic thermal modelling of PV performance and effect of heat capacity on the module temperature, Case Stud. Therm. Eng. 22 (2020), 100754, <https://doi.org/10.1016/j.csite.2020.100754>.