

SOLAR-POWERED PARALLEL IRRIGATION WITH IOT MONITORING SYSTEM

MUHAMMAD ARIF OSMAN¹, ROSHAHLIZA M RAMLI^{1,*},
NADZIRAH MOHD MOKHTAR²,
PUTRI NUR FARHANAH MOHD SHAMSUDDIN¹, WAHEB A. JABBAR³

¹Faculty of Electrical and Electronic Engineering Technology,
Universiti Malaysia Pahang Al-Sultan Abdullah,
26600 Pekan, Pahang, Malaysia

²Faculty of Civil Engineering Technology,
Universiti Malaysia Pahang Al-Sultan Abdullah,
26300 Kuantan, Pahang, Malaysia

³School of Engineering and the Built Environment, Birmingham City University,
Birmingham, B4 7XG, UK

*Corresponding Author: roshahliza@ump.edu.my

Abstract

Climate change affects the rainy and dry seasons, making it challenging to store and effectively utilize water resources. This problem will lead to crop losses and poor productivity in agriculture. A smart irrigation system in agriculture could be a solution by giving the ability to monitor the irrigation of the crops. An automated irrigation system might irrigate the crops and efficiently use the available water supplies. This study proposes an irrigation system using parallel water dripping system that is controlled and monitored using a Wi-Fi network, a wireless transceiver module, and a Real Time Clock (RTC) module. With the aid of this system, it is easier to control the solenoid water valve by using either manually on or off switch operations or a timer-based operation. The proposed irrigation system is also capable to be set for 5, 7, and 10 minutes from the developed system interface. Besides that, a multiple wireless sensor network were also integrated to observe the condition of the soil moisture and display it on the developed interface. The result showed that the sensor network detected the soil moisture content during the assigned watering time with about 83% accuracy based on two watering time conditions on three sensors. The soil moisture condition could be used as a parameter to let the irrigation operate based on the soil moisture data obtained from the sensors.

Keywords: Integrated system, Internet-of-Things, Irrigation, Renewable energy, Solar energy.

1. Introduction

By 2025, UNESCO projects that half of the world's population will be living in water-scarce areas, and by 2030, it is anticipated that 700 million people would have been forced to leave their homes due to severe water shortages. As 70% of the world's freshwater withdrawals are used for irrigated agriculture, the issue of water scarcity will also have an impact on the agricultural industries [1]. Since agriculture is the main user, water loss during transportation and distribution in irrigation networks is crucial. Approximately 60% of the water diverted for irrigation around the world is lost due to seepage, evaporation, and operation losses into the soil from the sloping surfaces and canal beds [2]. It must be emphasised that ineffective irrigation methods considerably increase water losses. This means that to increase agricultural productivity and improve food quality, particularly in areas where water scarcity or problems with gathering and distributing water are common, sustainable irrigation practices must be implemented in conjunction with effective water use [3].

However, climate change effects, according to [4], should not be overlooked in the pursuit of sustainable growth. On the contrary, extension service providers are currently lacking the proper training and readiness to aid farmers in managing agricultural risks through quick and affordable solutions [5]. Storing and effectively utilizing water resources becomes exceedingly challenging as climate change affects the patterns of rainy and dry seasons. Smart irrigation is needed in the agriculture industry as most irrigation water distribution is carried out manually, making it difficult to calculate exact losses [6]. This problem will lead to crop losses and poor products in agriculture.

Smart irrigation systems in agriculture can give the ability to monitor the irrigation of the crops and automated irrigation systems that keep providing crops water also utilize water resources effectively. Rising temperatures, irregular weather patterns, and increased intensity of droughts, floods, and cyclones have all been evidence of climatic change, resulting in massive losses in agricultural production and livestock populations [7]. These events will have a low quality of crop production as a sequence. Over the past few decades, irrigation technology has seen continual development. Several irrigation systems have been created, including flood irrigation, sprinkler irrigation, furrow irrigation, and drip irrigation.

The benefits and drawbacks of each have been examined concerning various types of crops, soils, and climatic conditions. In Australia, drip irrigation methods date back to the 1940s. This system was created with the development of polypropylene tubes. This system was not refined in Israel until twenty years later, after which it was distributed throughout the world. Compared to traditional irrigation systems such as flood irrigation or sprinklers, the drip irrigation system offers many advantages due to automation, microcontroller usage, sensors, and integrated systems [8]. Farmers frequently use sprinkler irrigation systems because of their high level of effectiveness. It is suitable for all sorts of crops and soil and is simple and cost-effective.

The use of portable systems is increasing globally and is getting more popular due to their adaptability and lower installation costs [9]. In most parts of the world, furrow irrigation is a common technique for surface watering. Filtration is a crucial parameter for this method's design, evaluation, and management since its fluctuations affect the hydraulic behaviour of furrow irrigation [10]. Generally

speaking, IoT was described as a "dynamic global network infrastructure built on standards and communication protocols with self-configuring capabilities. In an IoT, both physical and virtual things have unique identities and characteristics, are capable of deploying intelligent user interfaces, and may be included in an information network. IoT as radio-frequency identification (RFID)-enabled linked items with unique identifiers.

IoT's precise definition is still under development and is subject to the viewpoints utilized [11]. The phrases "Internet of Things" (IoT), "big data," and "artificial intelligence" (AI) are considered overused terms in the tech industry, but their impact has only recently become apparent. According to Google Trends search history, IoT and big data have garnered substantial attention from internet users worldwide in the past five to six years, whereas AI has been a topic of interest for over a decade. IoT is a technological concept that involves a vast network of digitally interconnected devices and equipment [12].

Implementation of the Internet-of-Things (IoT) in agriculture can be seen in the smart irrigation system [13,14]. Farmers generally operate on large areas of land where they grow diverse crops. Monitoring every field at all times is often impractical for a single individual. Unequal distribution of water can cause water-logging in certain parts of the land, while other parts receive insufficient or no water at all, leading to dry soil. Such conditions can cause damage to crops and result in financial losses for the farmer.. The Smart Irrigation System is based on Internet of Things (IoT) technology which can regulate the water pump in irrigating the farm area as well as monitor the moisture, temperature, and pressure of the soil. The Wi-Fi module and controller are used to control the smart irrigation system. It also has sensors built in to receive and transfer data to and from the cloud [15].

IoT technology can be utilized in agriculture, such as implementing a device for controlling and monitoring a greenhouse production environment. In the manufacturing process of agriculture, real-time data on crucial factors like temperature, humidity, and soil conditions are collected and transmitted wirelessly through a machine-to-machine support platform. Agriculture involves the art and science of cultivating soil, crops, and livestock, as well as processing and distributing human-grade plant and animal products. Agriculture is responsible for the production of the majority of the world's food and textile supply, including cotton, wool, and leather [16].

This smart irrigation system named Sistem Parit Tray (SPT) is designed based on the actual setup used in palm-oil industry at Rompin estate in Pahang, Malaysia and we added with a few major elements. First is a sensor that communicates with a system that collects soil moisture from crops. Next is data transfer to the IoT dashboard and SD card which both methods will go through a micro-controller then it will go to the IoT database wirelessly if there is an internet connection or will be stored in the SD card. Lastly is the IoT dashboard which is a web-based application that gives the user ability to control and monitor anywhere that has an internet connection. All the readings of the sensor can be accessed and downloaded by the user. If there is no internet connection connects to the microcontroller, the data can be accessed through an SD card. IoT dashboards can be a custom template to make users easy to use and friendly use. A prototype smart irrigation system has been developed to collect data required using an IoT dashboard and analyse the data.

Although many works in the solar powered irrigation system have been found in the literature, the technology adoption in Malaysia is still low and the local experts that can integrate the system with the typical crops of Malaysia, such as oil palm, rubber, pineapple, paddy, chilies, etc., are scarce. Therefore, this study will explore the potential of the SPT system for parallel irrigation mode with the aim to be applied in different types of crops and be capable of scaling up based on the real agricultural areas. With the implementation of this system, it is hoped that the system will be able to use water effectively, since disruptions in irrigation can have significant economic impacts. Crop failures and reduced yields can lead to food price volatility, impacting both consumers and producers. In terms of environmental and economic benefits, this system is eco-friendly, as they produce clean energy without greenhouse gas emissions, reducing the carbon footprint compared to traditional fossil-fuel-powered irrigation methods while lead to substantial cost savings in the long term, as it eliminates the need for expensive fuel and reduces operational and maintenance costs.

2. Development of Smart Parallel Irrigation System

This paper illustrates the experimental design of a smart parallel irrigation system powered by solar energy with an embedded microcontroller for watering the seedlings for a plant nursery.

Figure 1 shows the overall smart parallel irrigation system setup, which consists of six main components: the actuation unit, the subscriber unit, the transmitter, the IoT dashboard, the local controller and the sensing unit. Most electronic components are getting the power supply from the mini solar station positioned on site. This setup of a smart parallel irrigation system is suitable to be implemented at the plantation site which is far from the national electrical grid and at a remote location.

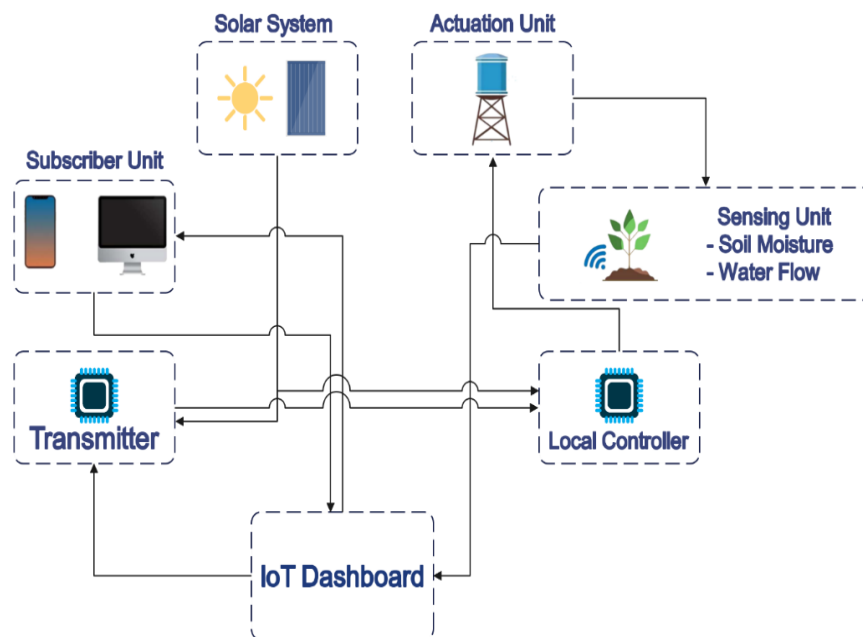
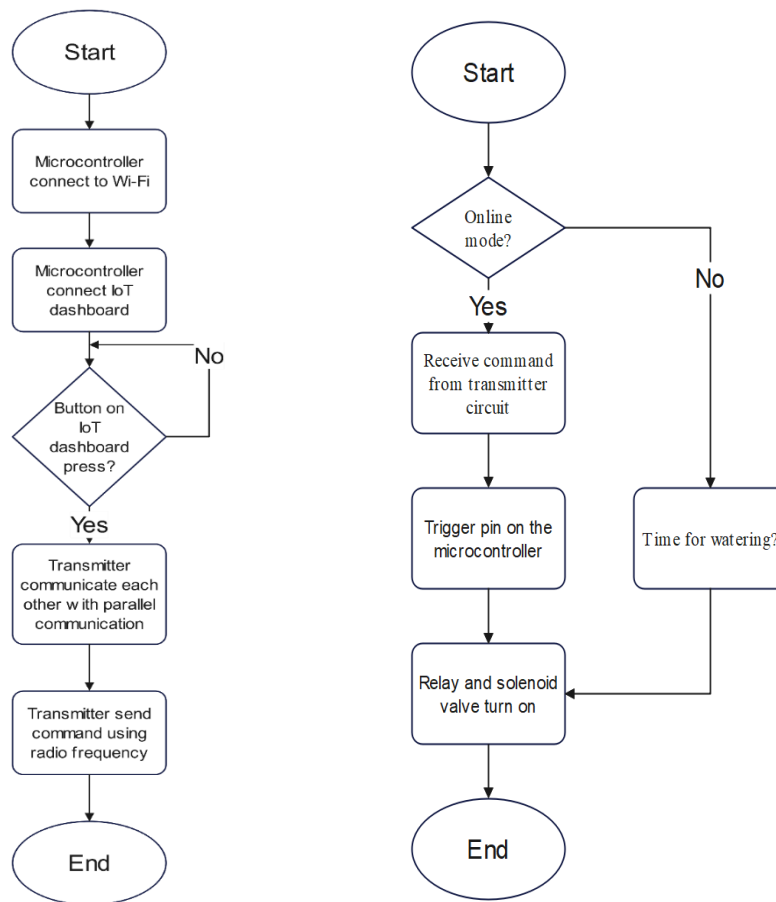

Fig. 1. System diagram.

2.1. Irrigation control system

For this system, a local controller is used as the irrigation control system and sensing circuit unit. This system has two methods which are online and offline method. The local controller circuit will be divided into two sections which are the transmitter and receiver. The transmitter circuit will have two microcontrollers, both microcontrollers will communicate with each other using binary code through parallel communication. One of them will communicate with IoT Dashboard through Wi-Fi while the other one will communicate with the receiver circuit through radio frequency.

Figure 2(a) shows the operation flows of the communication system transmission of the proposed system. Afterwards, the receiver circuit will receive a command from the transmitter circuit through radio frequency. There are a few electronic components that are connected to the receiver circuit which are a relay and a real-time clock. The receiver circuit can operate on its own by depending on a real-time clock to turn on and off the irrigation system. Figure 2(b) shows how the receiver circuit is operated.



(a) Transmitter operation.

(b) Receiver operation.

Fig. 2. Communication transmission operation flow.

For the setup of the irrigation system, there will be a tank using gravitational force that supplies water to the irrigation system. Meanwhile, before the water reaches the parit tray it will be going through the water flow sensor and then it will distribute to the parit tray. The soil moisture sensor has been placed on the end of the parit tray to make sure water is able to reach the end of the parit tray and also able to supply enough water to the seedlings. Figure 3 shows the full setup of the irrigation system.

Figure 4 shows the setup of the system with a solenoid valve, hand valve and water flow sensor which are connected, then there are seedling trays with water drip tapes connected to the water outlet after the valves. Beside the seedling trays, a local controller is positioned to control the water valves and soil moisture sensors which are placed at the end of the trays. All these components are powered by solar energy placed near the system.

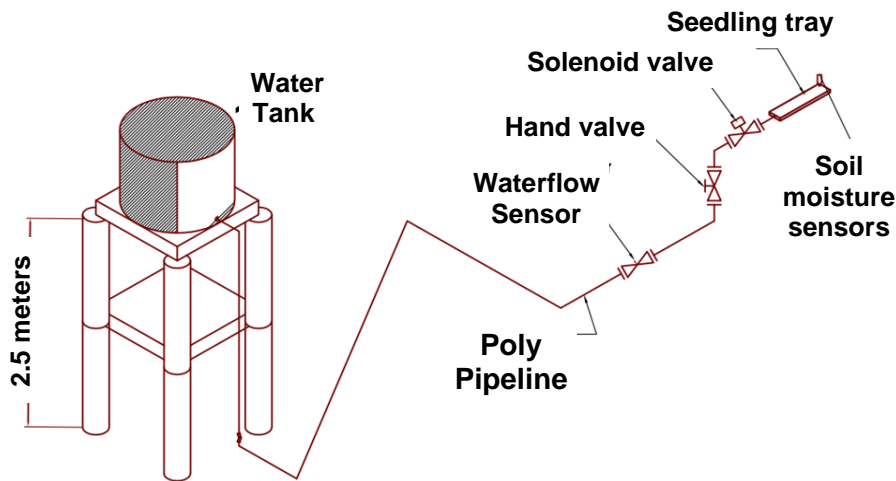

Fig. 3. Irrigation system setup.

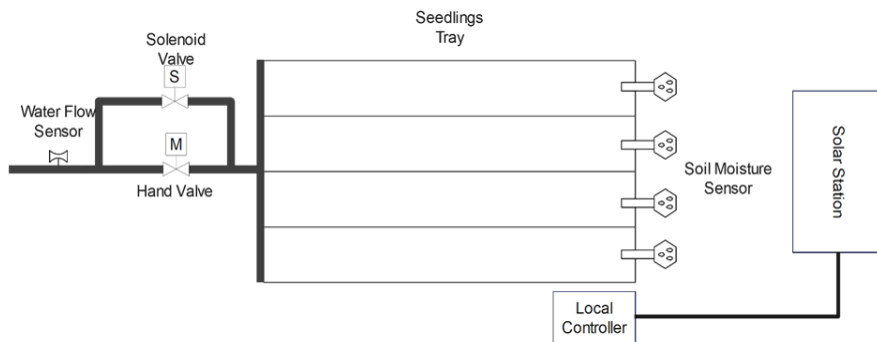

Fig. 4. Seedlings tray setup.

Figure 5 shows the drawing of an aerial view of the seedling tray setup for this system. The placement of seedling trays is positioned 63 cm from the ground and up to 12 meters long, parallel with the water outlet from the water valves shown in Fig.

5. This setup is more ergonomic for the worker in handling the seedlings on the parit tray. With this system, it can cater to up to 2400 seedlings in one operation cycle. The reason behind this setup is to provide an ergonomic work environment for the workers while operating the system and inspecting the growth of the seedlings as well as to avoid the interruption of the weeds on the growth of the seedlings.

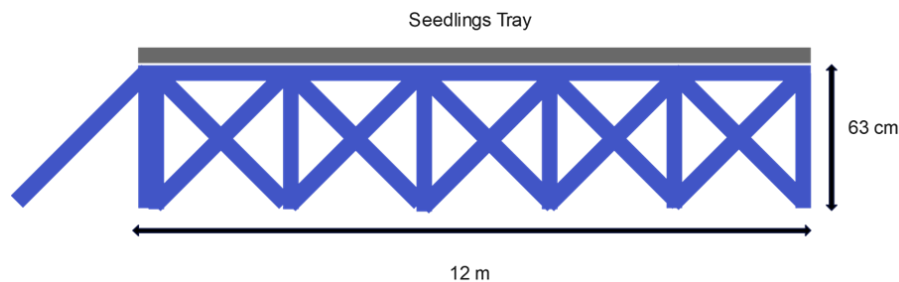

Fig. 5. Side view seedlings tray setup.

2.2. Power generation using solar energy

Since the pre-nursery site is located far away from the normal electricity source, this project recommends a stand-alone photovoltaic (PV) system to be developed to power up the automated SPT. The power requirement of the proposed automated SPT has been investigated to obtain information on the number of PV panels that need to be installed for this project. Below are the steps to design the stand-alone PV system.

2.2.1. Calculation of total energy consumption

The total energy consumption of the automated SPT is calculated and presented in Table 1.

Table 1. Calculation of total watt hour per day.

Appliance	Output watt	Hours/Day	Quantity	watthour/Day
Solenoid Valve	12 V x 0.5 A = 6W	0.34	42	85.68 Wh/day
Arduino	5 V x 75 mA = 0.375 W	11.0	4	16.5 Wh/day
Total				102.18 Wh/day

From the calculation, the automated SPT requires 102.18 Wh per day to power up 42 units of solenoid valve for 0.34 hours per day and 4 units of Aduino for 11 hours per day.

2.2.2. Size and number of photovoltaic (PV) panel

The information on total energy consumption is depending on the minimum number of PV panels that are needed by the proposed system. The calculation using Eq. (1) is done with the assumption of using a PV panel 4 hours a day as peak sunlight hour which has the highest irradiance of the PV cells, and each PV panel has 34% efficiency. By using the total watt hour per day calculated in Table 1 in Eq. (1), the system needs 25.55 watt to power up all the components.

$$\text{Energy needed} = \frac{\text{total watt hour per day}}{\text{peak sunlight hour}} \tag{1}$$

$$\text{Total energy} = \frac{102.18}{4} = 25.55 \text{ watt}$$

Using the above information, the capacity of PV panel can be calculated by using Eq. (2) whereby the total energy needed by the system divided by the irradiance efficiency of the PV panel. From Eq. (2), the power of the PV panel capacity is calculated to be 75.13 watt. Therefore, it is desirable to use one module of 100-watt PV panels or two modules of 50-Watt PV panels to accommodate the power of PV panel's capacity.

$$\text{Total Watt power of PV Panel capacity} = \frac{(\text{Energy needed})}{(\text{Efficiency})} \tag{2}$$

$$\text{Total Watt power of PV panel capacity} = \frac{25.55}{0.34} = 75.13 \text{ watt}$$

2.3. Soil water capacity

Following irrigation, the soil drains to the field's capacity. The amount of water that a specific volume of soil should hold is known as the field capacity. When there isn't a water source nearby, the crop draws moisture from the root zone, lowering the water level. A soil moisture sensor is a component of the recommended system that measures the moisture content of the irrigation medium. The ability of the soil to absorb available water for plant growth is known as soil water availability. The dielectric contrast between water and soil, where dry soils have a relative permittivity of between 2 and 6 and water has a value of about 80, is used by capacitive soil moisture sensors to measure moisture levels in the soil.

Figure 6 shows the circuit drawing of four units of soil moisture sensors connected to a microprocessor as a local controller to monitor the moisture percentage of the soil in the irrigation system. This figure illustrated the usage of multiple soil moisture sensors in detecting the soil moisture content at the end of the developed SPT system and verifying the water managed to reach certain moisture level needed by the crops.

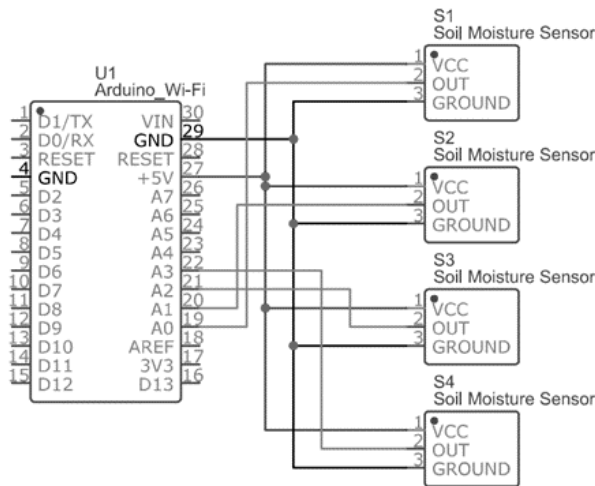

Fig. 6. Circuit drawing of single soil moisture sensor for local controller.

3. Results and Discussion

This section explained the data that have been collected and the result of the graphical user interface that has been integrated with the smart irrigation system. All soil moisture sensors that have been installed in the prototype system have been tested. The smart irrigation system is depicted in Fig. 7 that shows the dimensions of each component in centimetres. The items used in setting up the SPT and the specification of the sensor is shown in Table 2. The seedling trays were placed at the end of the platform, about 10 meters from the tape connectors that connected to the solenoid valve.

In this system, plants are grown in nutrient solutions rather than soil. Plant roots are grown in a nutrient solution contained in a grow tray, with the roots submerged. Fast ring connectors are used to connect the piping system to the seedling trays to water them. This type of connector is commonly used in agricultural systems. Rod has been placed beneath the seedling tray to keep it from falling.

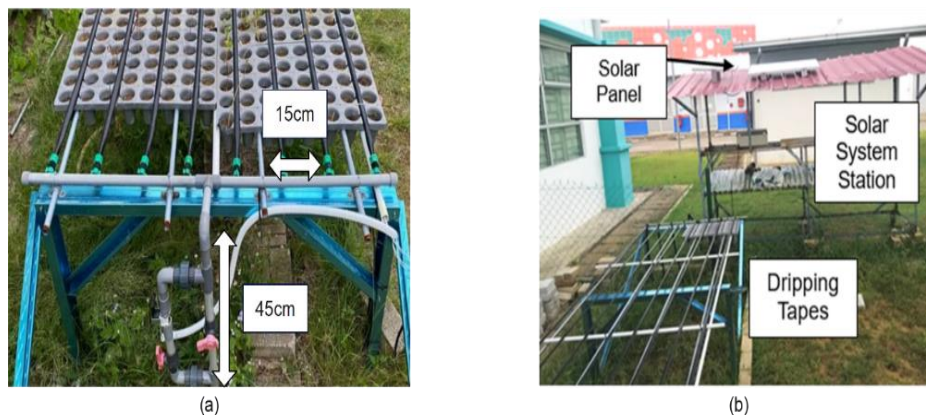

Fig. 7. The actual prototype setup of the parallel drip irrigation system.

Table 2. The item used in the SPT.

Item	Amount
Seedling trays	4 units (160 holes)
Piping system	8 connections
Fast ring Connectors Tape	8
Soil Moisture Sensor Specification	
Operating voltage	3.3 - 5.5 V
Output voltage	0 - 3.0 V
Operating Current	5 mA
Weight	15

3.1. IoT dashboard

The IoT dashboard integrated with smart irrigation is friendly user because it can be customized based on the user's requirements. For smart irrigation, there are 4 sections of the IoT Dashboard. The first part is the valve monitoring section, this section gives the ability to the user to control the solenoid valve manually and turn it on and off. There are two types to control the solenoid valve, first is regular on/off

then timer on/off for 5,7 or 10 minutes depending on the user. Users also can access the data to monitor when the solenoid valve is on or off. Figure 8 shows the IoT dashboard for valve monitoring.

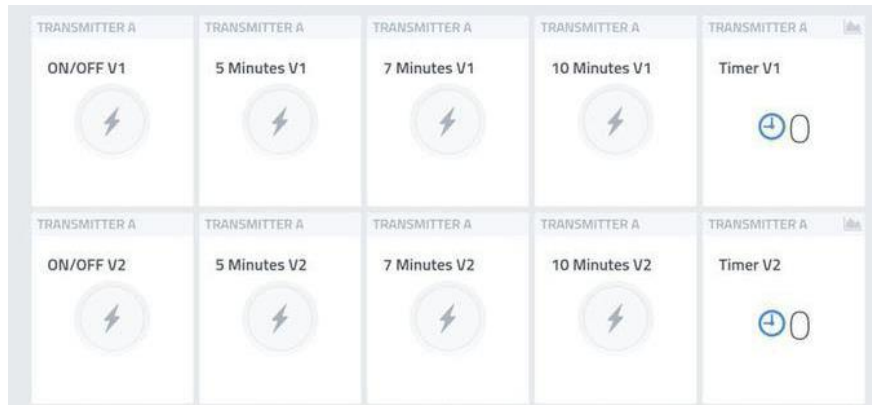

Fig. 8. Solenoid valve monitoring.

Next, for sensor monitoring, this system gives the ability to the user to monitor the live data collection of the sensor and recorded data of the sensor. There are variety of pattern readings that can be shown on the IoT dashboard. Referring to Fig. 9, there are two types of sensor values; in numerical value and also a graph pattern.

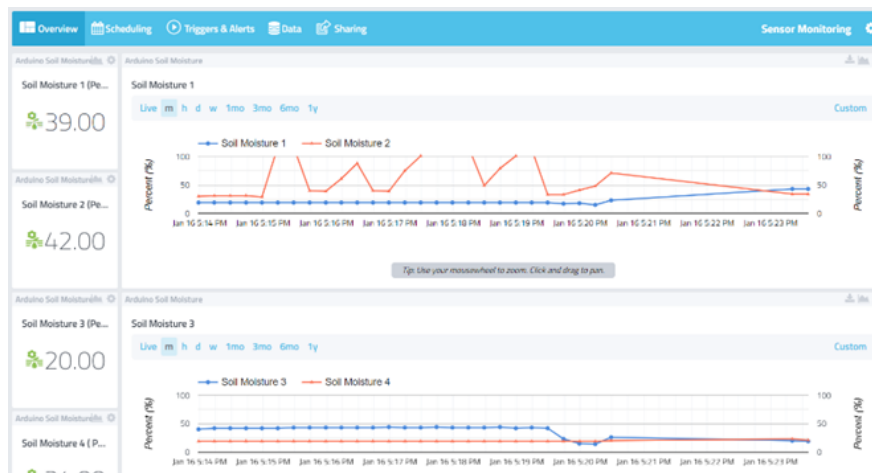

Fig. 9. Sensor monitoring dashboard.

In the event section, the water valve operation schedule can be set online, these triggers only happen if the micro-controller is connected to the internet. This operation is the same as the offline on/off scheduling, on the valve at 8 am and 5 pm for 10 minutes. The command to turn on the valve will be sent to the transceiver circuit and then the transceiver circuit will send the command to the receiver circuit. Figure 10 shows the scheduling section.

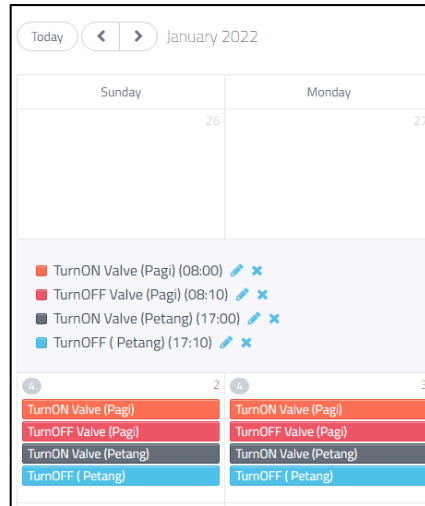

Fig. 10. Scheduling section on IoT dashboard.

All the data that has been sent from the microcontroller can be accessed from the IoT dashboard in the data logging section. This section can filter how we want to collect data. For example, only need soil moisture 1 reading on a certain day. All the data can be downloaded and converted into excel format, which helps the user to analyse the data more conveniently. Figure 11 shows the data logging system.

Timestamp	Device Name	Channel	Sensor Name	Sensor ID
2022-01-22 6:27:33	Arduino Soil Moistu...	0	Soil Moisture 1 & Soil Moisture 2	810e9140-587b-11ec-8da3-474359a983...
2022-01-22 6:27:32	Arduino Soil Moistu...	3	Soil Moisture 4	c54703b0-587b-11ec-bbfc-979c238041...
2022-01-22 6:27:32	Arduino Soil Moistu...	1	Soil Moisture 2	96fd5810-587b-11ec-ad90-75ec5e25c7a4
2022-01-22 6:27:32	Arduino Soil Moistu...	2	Soil Moisture 3 & Soil Moisture 4	aa1fd780-587b-11ec-9f5b-45181495093e
2022-01-22 6:27:17	Arduino Soil Moistu...	1	Soil Moisture 2	96fd5810-587b-11ec-ad90-75ec5e25c7a4
2022-01-22 6:27:17	Arduino Soil Moistu...	3	Soil Moisture 4	c54703b0-587b-11ec-bbfc-979c238041...

Fig. 11. Data logging system.

3.2. Reading soil moisture

Figure 12 depicts the soil moisture reading of sensor 1 (S1), sensor 2 (S2), sensor 3 (S3) and sensor 4 (S4) in a graph pattern. From the reading of sensor 2, 3 and 4, the trend of the graph is similar. The reading is high when the time reached 8 am and 5 pm. It is because the valve is energized by the coil to flow the water to the soil. It makes the reading of S1 maintain the reading. Reading of soil moisture 1 is average because lack of water flow to the particular tray. It is done purposely to analyse the reading of soil moisture. From that, can make a comparison between each reading of soil moisture. Referring to Fig. 12, each data from soil moisture sensor is not the same even though soil itself receive water at the same time which is 8 am and 5 pm and also using same type soil moisture sensor. This is because the placement of parit tray and setup for prenursery is not symmetrical thus giving effect to the amount of soil receiving water.

In Fig. 12, the sensors S3 and S4 performed well in detecting moisture content during watering time. However, sensor S2 had a delay in detecting moisture during evening watering time due to placement of the sensor inside the tray hole during data collection was slightly out. This result was then verified by the percentage taken from the sensor reading shown in Table 3. The result showed that the sensor network detected the soil moisture content during the assigned watering time with about 83% accuracy based on two watering time conditions on three sensors used in this study. More accurate data can be obtained with other type of sensor such as resistive, volumetric, neutron probes and others.

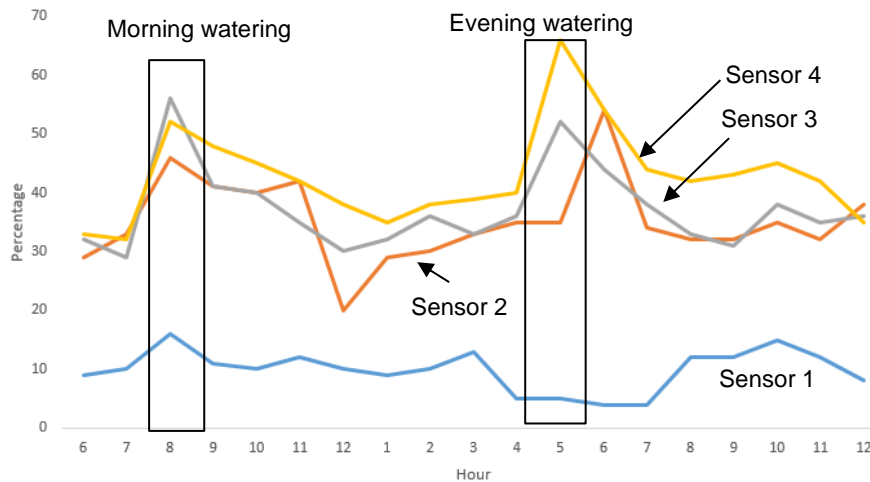

Fig. 12. Soil moisture sensor data taken hourly.

Table 3. Data of Soil Moisture Sensors.

Time (hour)	Sensor (%)			
	S1	S2	S3	S4
0600	9	29	32	33
0700	10	33	29	32
0800	16	46	56	52
0900	11	41	41	48
1000	10	40	40	45
1100	12	42	35	42
1200	10	20	30	38
1300	9	29	32	35
1400	10	30	36	38
1500	13	33	33	39
1600	5	35	36	40
1700	5	35	52	66
1800	4	54	44	54
1900	4	34	38	44
2000	12	32	33	42
2100	12	32	31	43
2200	15	35	38	45
2300	12	32	35	42
2400	8	38	36	35

4. Conclusions

This paper discusses the IoT-based smart irrigation monitoring system that could assist users in reducing the work burden and providing accurate analysis readings. This project is a pilot test before the actual system is installed in a real environment on the oil-palm plantation site. In this system, by utilising the IoT dashboard, the system can provide users with immediate access. The system is capable of tracking the sensors and detecting critical changes in input. The system's convenience is expected to boost productivity while decreasing water consumption. Confidently state that this smart irrigation system will improve the farming experience for all users. All four sections in this system must be functioning for this project to be accomplished. Although the system is in good working order, it could be improved in the future. Only one type of sensor was used for this project. However, for the upcoming project, additional sensors such as a rain sensor, pH sensor, and humidity and temperature sensor could be added. All these sensors are commonly used in smart farming. There are lots of improvements that can be made to this project, for example by adding more sensors such as pH sensor, temperature, humidity etc. Integrate more smart functions in the system such as triggering the solenoid valve when soil moisture readings are in a certain condition. Lastly, recreating the transmitter circuit became simpler and easier to troubleshoot and became more future-proof.

Acknowledgement

This research was financially supported by Postgraduate Grant Scheme, Universiti Malaysia Pahang Al-Sultan Abdullah, PGRS230340.

Abbreviations

AI	Artificial Intelligent
IOT	Internet of Things
RFID	Radio Frequency Identification
PV	Photovoltaic

References

1. Ali, M.; Man, N.; Abd Latif, I.; Melissa Muahram, F.; and Omar, S.Z. (2018). The use of information and communication technologies in agricultural risk management by the agricultural extension services in Malaysia. *International Journal of Agriculture Environment and Food Science*, 2(1), 29-35.
2. Allen, R.G.; Pereira, L.S.; Raes, D. Smith, M. (1998). Crop evapotranspiration-guidelines for computing crop water requirements - FAO *Irrigation and Drainage Paper 56; Food and Agriculture Organization (FAO)* of the United Nations: Rome, Italy, 1998;
3. Asean Institute of Technology/United Nation Environment Program (2010) Assessment of capacity gaps and needs of Southeast Asia Countries in addressing impacts, vulnerability and adaptation to climate change. Bangkok, Thailand.
4. García-Tejero, I.F.; Durán-Zuazo, V.H.; Muriel-Fernández, J.L., and Rodríguez-Pleguezuelo, C.R. (2011). *Water and Sustainable Agriculture*. Springer.

5. Gokhale, P.; Bhat, O.; and Bhat, S. (2007). Introduction to IOT. *International Advanced Research Journal in Science, Engineering and Technology*, 5(1), 41-44.
6. Ingraio, C.; Strippoli, R.; Lagioia, G.; and Huisingh, D. (2023). Water scarcity in agriculture: An overview of causes, impacts and approaches for reducing the risks. *Heliyon*, 9(8), e18507.
7. Misra, N.N.; Dixit, Y.; Al-Mallahi, A.; Bhullar, M.S.; Upadhyay, R.; and Martynenko, A. (2022). IoT, big data, and artificial intelligence in agriculture and food industry. *IEEE Internet of Things Journal*, 9(9), 6305-6324.
8. Moravejalahkami, B. (2020). Methods of infiltration estimation for furrow irrigation. *Irrigation and Drainage*. 69(1), 52-62.
9. Mulder, M. (2017) A five-component future competence (5CFC) model. *The Journal of Agricultural Education and Extension*, 23(2), 99-102.
10. Niragire, T.; Süheri, S.; and Kumar Pande, S. (2021). Performance evaluation of hand-move sprinkler irrigation system: A case study in Rwanda. *International Journal of Innovative Approaches in Agricultural Research*, 5(1), 37-51.
11. Omar, A.A.; Omuto, C.; and Ondieki, S. (2019). Determination of irrigation supply efficiency in challenging environment case study of Bal'ad district, Middle Shabelle Region in Somalia. *Computational Water, Energy, and Environmental Engineering*, 8(1), 1-10.
12. Ramli, R.M.; and Jabbar, W.A. (2022). Design and implementation of solar-powered with IoT-Enabled portable irrigation system. *Internet of Things and Cyber-Physical Systems*, 2, 212-225.
13. Sivakumar, M.V.K.; and Stefanski, R. (2010). Climate change in South Asia. *Climate Change and Food Security in South Asia*. Springer.
14. Velasco-Muñoz, J.F.; Aznar-Sánchez, J.A.; Batlles-de-laFuente, A.; and Fidelibus, M. D. (2019). Sustainable irrigation in agriculture: An analysis of global research. *Water*, 11(9), 1-26.
15. Wu, R.-S.; Liu, J.-S.; Chang, S.-Y.; and Hussain, F. (2017). Modeling of mixed crop field water demand and a smart irrigation system. *Water*, 9(11), 885.
16. Zhao, J.C.; Zhang, J.F.; Feng, Y.; and Guo, J.X. (2010). The study and application of the IOT technology in agriculture. *Proceedings of the 2010 3rd IEEE International Conference on Computer Science and Information Technology*, Chengdu, China, 462-465.